

120CR-B 160CR-B Electronic Cash Register



User's Manual

START-UP is QUICK and EASY!
Simple to use!
4 departments
Automatic Tax Calculations
Calculator function

CASIO®

EU

DI

UK

Introduction

Thank you very much for purchasing this CASIO electronic cash register.
START-UP is QUICK and EASY!

Part-1 of this User's Manual can help you make a quick start.

Once you have mastered the QUICK START operations, you will undoubtedly want to expand your use of this machine by studying other sections of Part-2.

Original Carton/Package

If for any reason, this product is to be returned to the store where purchased, it must be packed in the original carton/package.

Location

Locate the Cash register on a flat, stable surface, away from heaters or areas exposed to direct sunlight, humidity or dust.

Power Supply

Your cash register is designed to operate on standard household current (120V, 220V, 230V or 240V; 50/60Hz). Do not overload the outlet by plugging in too many appliances.

Cleaning

Clean the cash register exterior with a soft cloth which has been moistened with a solution of a mild neutral detergent and water, and wrung out.

Be sure that the cloth is thoroughly wrung out to avoid damage to the printer.

Never use paint thinner, benzene, or other volatile solvents.

Contents

| | |
|--|---|
| Getting to know your cash register | 2 |
| Daily Job Flow | 4 |

Part-1 QUICK START OPERATION **5**

(You can operate this ECR on a basic level by reading the following sections)

| | |
|--|----|
| 1. Initialization | 5 |
| 2. To Select the Date Format and Monetary Mode | 5 |
| 3. Loading Paper | 6 |
| 4. Basic Programming for QUICK START – TIME/DATE | 7 |
| 5. Basic Operation after Basic Programming | 9 |
| 6. Daily Management Report | 13 |

Part-2 CONVENIENT OPERATION **15**

(Please keep these sections to expand your use.)

| | |
|------------------------------|----|
| 1. Various Programming | 15 |
| 2. Various Operations | 24 |

Part-3 CALCULATOR FUNCTION..... **28**

| | |
|--------------------------|----|
| 1. Calculator Mode | 28 |
|--------------------------|----|

Part-4 USEFUL INFORMATION **30**

| | |
|--------------------------|----|
| 1. Troubleshooting | 30 |
| 2. Specifications | 31 |

Before you start

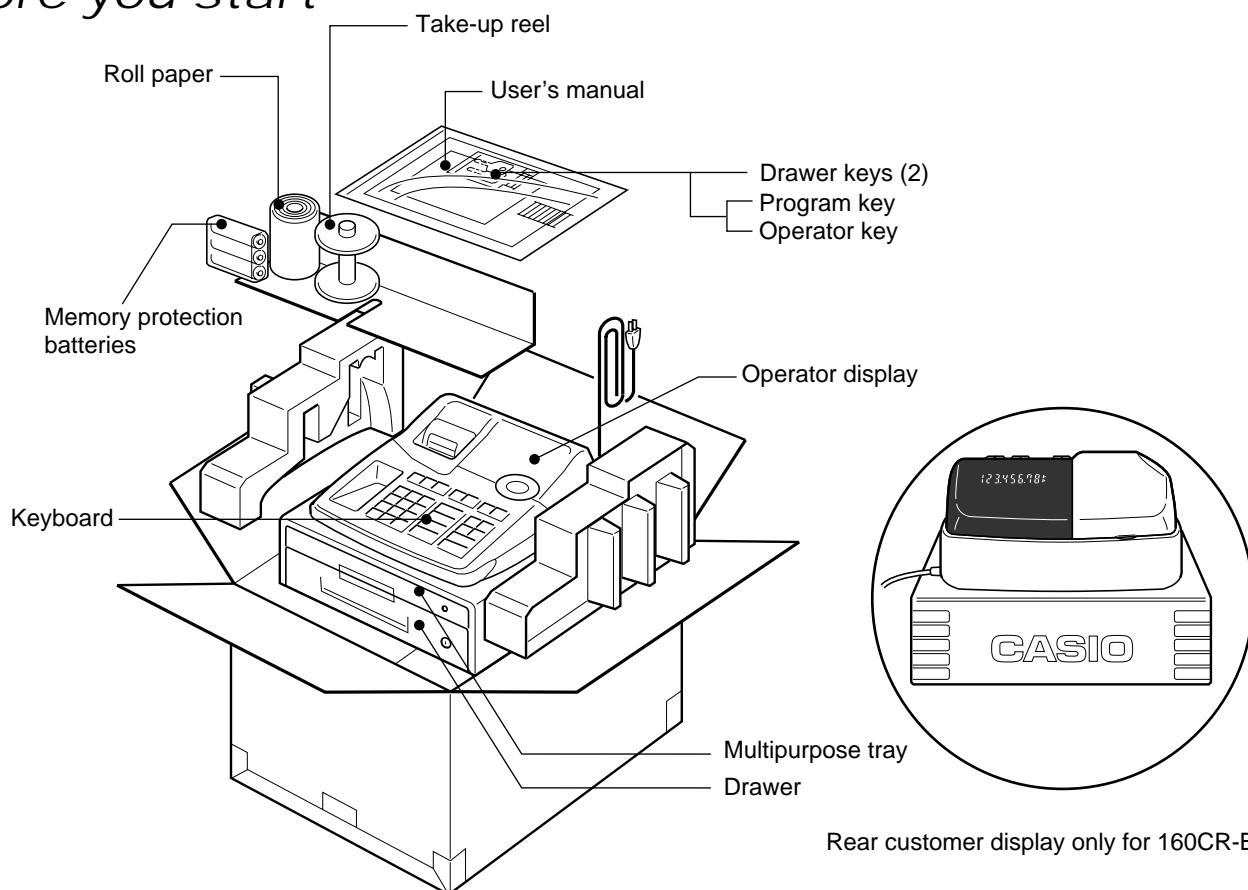

Getting to know your cash register

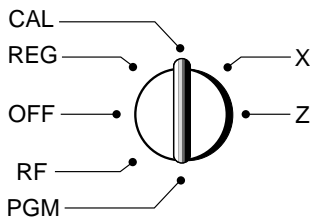

The position of the Mode Switch controls the type of operations you can perform on the cash register. The PROGRAM Key (marked PGM) that comes with the cash register can be used to select any Mode Switch setting, while the OPERATOR Key (marked OP) can be used to select OFF, REG or CAL only.

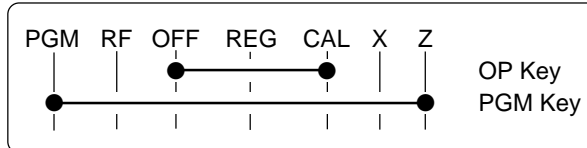

Note:

An error is generated (E01 displayed) whenever the position of the Mode Switch is changed during registration.

OFF

In this position, the power of the cash register is off.

REG (Register)

This is the position used for registration of normal transactions.

RF (Refund)

This is the position used for registration of refunds.

CAL (Calculator)

This is the position used for calculator mode.

PGM (Programming)

This is the position used to program the cash register to suit the needs of your store.

X (Read)

This is the position used to produce reports of daily sales totals without clearing the totals.

Z (Reset)

This is the position used to produce reports of daily sales totals. This setting clears the totals.

Displays

Operator Display

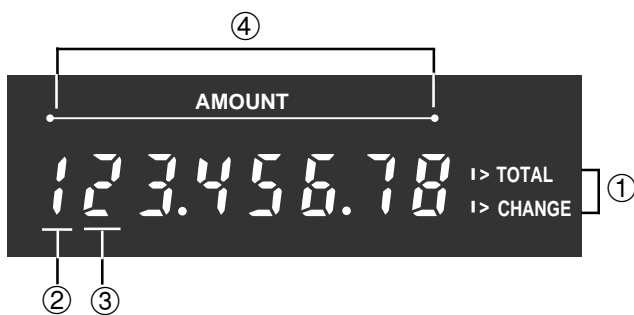

Rear Customer Display (only for 160CR-B)

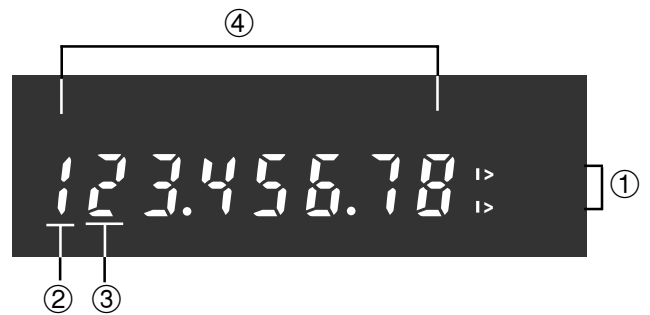

① **Total/Change Display**

The total (upper segment) or change (lower segment) sign appears when a subtotal, total or change is obtained.

② **Department Number Display**

Anytime you press a department key to register a unit price, the corresponding department number appears here.

③ **Number of Repeat Display**

Anytime you perform "repeat registration" (page 9), the number of repeats appears here.

Note that only one digit is displayed for the number of repeats.

④ **Numeric Display**

Entered values (unit prices or quantities) and calculated values (subtotals, totals or change amount due) are displayed here. The capacity of the display is 8 digits.

This part of the display can be used to show the current time or date between registrations (page 26).

Keyboard

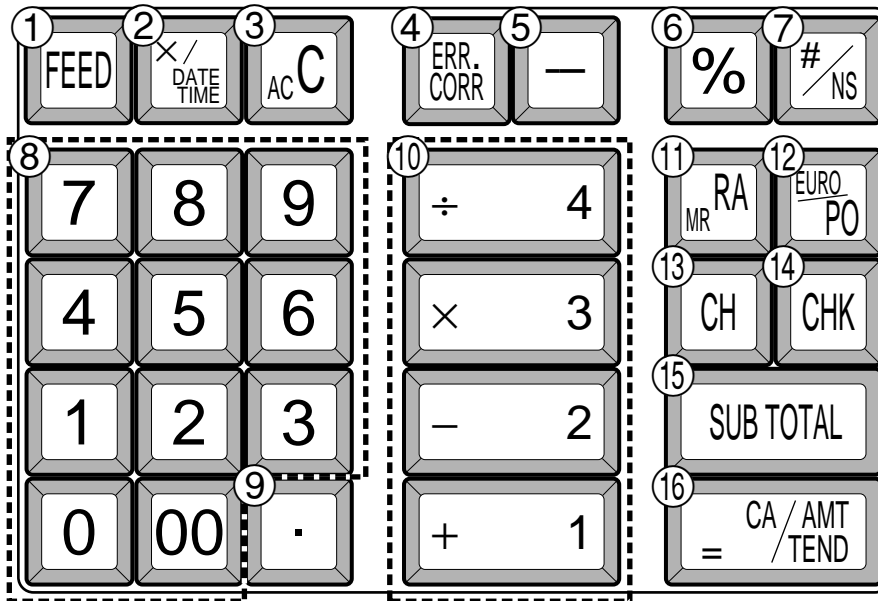

Certain keys have two functions; one for register mode and one for calculator mode.

In this manual, we will refer to specific keys as noted below to make the operations as easy to understand as possible:

Register Mode

- ① Feed Key
- ② Multiplication/Date Time Key
- ③ Clear Key
- ④ Error Correction Key
- ⑤ Minus key
- ⑥ Percent Key
- ⑦ Reference Number/No Sale Key
- ⑧ Numeric Keys and 2-zero key
- ⑨ Decimal key
- ⑩ Department Keys
- ⑪ Received On Account Key
- ⑫ Euro/Paid Out Key
- ⑬ Charge Key

- ⑭ Check Key
- ⑮ Subtotal Key
- ⑯ Cash Amount Tendered Key

Calculator Mode

- ③ AC Key
- ⑥ Percent Key
- ⑧ Numeric Keys and 2-zero key
- ⑨ Decimal key
- ⑩ Arithmetic Operation Keys
- ⑪ Memory Recall key
- ⑯ Equal Key

Daily Job Flow

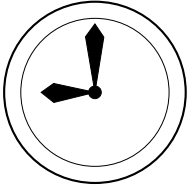

Before Opening The Store

1. Plugged in?
2. Enough Roll Paper?
3. Date and Time is correct?
4. Enough small change in the drawer?

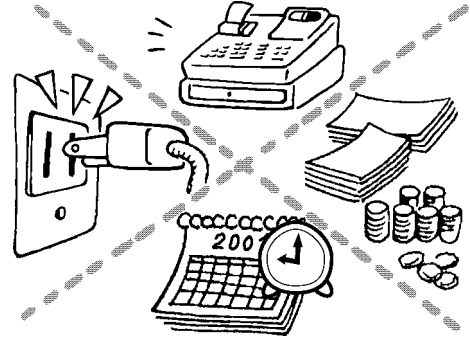

While The Store Is Open

1. Registrations.
2. Issuing latest daily sales total if needed.
(Generating report by Mode Switch to X position.)

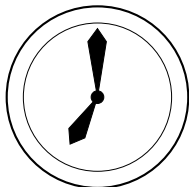
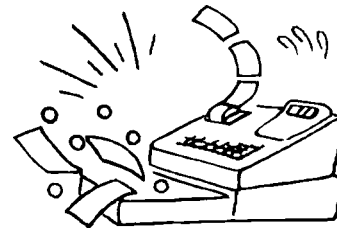

After Closing The Store

1. Issuing Daily Sales Total.
(Resetting report by Mode Switch to Z position.)
2. Picking up money in the drawer.
3. Turn the Mode Switch to OFF.

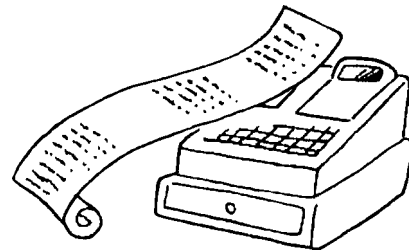

1. Initialization and Loading Memory Protection Battery

Important

You must initialize the Cash register and install the memory protection batteries before you can program the cash register.

► To initialize the cash register

1. Set the Mode Switch to OFF.
2. Plug the power cord of the cash register into an AC outlet.
3. Load the memory protection batteries.
4. Set the Mode Switch to REG.

► To load the memory protection batteries

1. Remove the printer cover.
2. Press down on the oval just behind the printer paper inlet, and slide the battery compartment cover toward the back of the cash register.
3. Load 3 new UM-3, R6P (SUM-3) or LR6 (AM-3) type batteries into the compartment. Be sure that the plus (+) and minus (-) ends of each battery are facing in the directions indicated by the illustrations inside the battery compartment (Figure 1).
4. Slide the memory protection battery compartment cover back into place.
5. Replace the printer paper and printer cover.



(Figure 1)

REPLACE MEMORY PROTECTION BATTERIES AT LEAST ONCE EVERY YEAR.

2. To Select the Date Format and Monetary Mode

You can select the date format and Monetary mode after initialization depending on the requirements in your area. Default date format is Day/Month/Year. Default Monetary Mode is Add 2.

Example:

Change the date format to Month/Day/Year, and change Monetary mode to Add 3.

1. Set the Mode Switch to PGM.
2. Press the following keys.

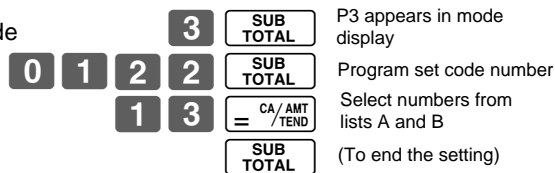

| Date Format Selections | |
|------------------------|---|
| Year/Month/Day | 0 |
| Month/Day/Year | 1 |
| Day/Month/Year | 2 |

| Monetary Mode Selections | |
|--------------------------|---|
| Add 0 (0.) | 0 |
| Add 1 (0.0) | 1 |
| Add 2 (0.00) | 2 |

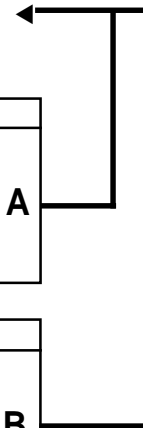

3. Loading Paper Roll And Replacing The Printer's Ink Roll

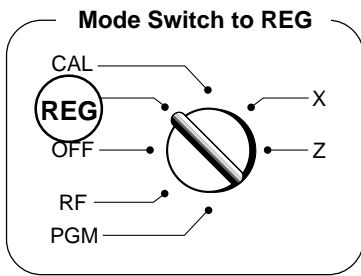

1. To load journal paper

- Remove the printer cover by lifting up the back.



- Put a roll of journal paper into the holder.
- Cut the leading end of the roll paper with scissors and insert the paper into the inlet.



- Press the **FEED** key until 20 or 30 cm of paper is fed from the printer.
- Roll the paper onto the take-up reel a few turns.



- Set the left plate of the take-up reel and place the reel into the register.



- Press the **FEED** key to take up any slack in the paper.
- Replace the printer cover by placing the cover's front tab into the register's groove.



2. To remove journal paper

- Remove the printer cover following the instructions above.
- Press the **FEED** key until approximately 20cm of the paper is fed from the printer.
- Cut off the roll paper.



- Remove the take-up reel from the printer and take off the left plate of the reel.
- Remove the journal paper from the take-up reel.



- Cut off the paper left in the printer and press the **FEED** key until the remaining paper is fed out from the printer.



- Remove the core of the paper.



- Load new paper following the instructions above, and replace the printer cover.

Default printer setting is for Journal. To print receipts, please refer to 1-7-3 on page 20 to switch the printer for Receipt or Journal.

▶ To load receipt paper

- To use the printer to print receipts, follow steps 1 through 4 of "To load journal paper".
- Pass the leading end of the receipt paper through the printer cover's paper outlet and replace the printer cover.
- Tear off any excess paper.

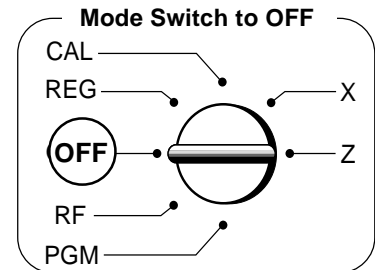

▶ To replace the ink roll

- Remove the printer cover.
- Lift up the tab on the ink roll marked "PULL UP".



- Install a new Ink Roll and press it down firmly but gently until it snaps into place.
- Replace the printer cover onto the cash register.
- Press the **#/NS** key to check for correct operation.

Options: Roll paper – P-5860
Ink Roll – IR-40

4. Basic Programming for QUICK START

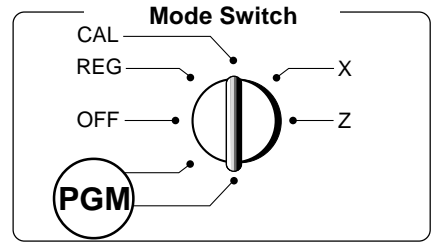

Part-1

| Procedure | Purpose |
|---|--|
| <p>1. Insert the PROGRAM key (marked "PGM") and rotate to PGM position.</p> | <p>Programming</p> |
| <p>2. Press the following keys to set the current time.</p> <p>Example: 13:18 PM = 1318</p> <div style="display: flex; align-items: center; justify-content: center;"> <div style="text-align: center; margin-right: 10px;"> <p>1 3 1 8</p> <p>Time Minutes</p> </div> <div style="margin-right: 10px;"> <p>1 SUB TOTAL</p> </div> <div style="margin-right: 10px;"> <p>X/DATE TIME</p> </div> <div> <p>AC C</p> </div> </div> <p>P appears in mode display (to end the time setting)</p> <ul style="list-style-type: none"> • Enter 4 digits • 24-hour time format | <p>Setting the current time</p> |
| <p>3. Press the following keys to set the current date.</p> <p>Example: January 8, 2002 = 020108</p> <div style="display: flex; align-items: center; justify-content: center;"> <div style="text-align: center; margin-right: 10px;"> <p>0 2 0 1 0 8</p> <p>Year Month Day</p> </div> <div style="margin-right: 10px;"> <p>1 SUB TOTAL</p> </div> <div style="margin-right: 10px;"> <p>X/DATE TIME</p> </div> <div> <p>AC C</p> </div> </div> <p>P appears in mode display (to end the date setting)</p> <ul style="list-style-type: none"> • Enter 6 digits • Enter last 2 digits for year set. (2002 → 02) | <p>Setting the current date</p> |
| <p>4. You can set only one tax calculation system – either an add-on or an add-in depending on the laws in your area. Press the following keys to set the tax rate.</p> <p>Example: Set tax rate 1 as 5.25% and tax rate 2 as 10%.</p> <div style="display: flex; align-items: center; justify-content: center; margin-bottom: 10px;"> <div style="text-align: center; margin-right: 10px;"> <p>3 SUB TOTAL</p> </div> <div> <p>P3 appears in mode display</p> </div> </div> <div style="display: flex; align-items: center; justify-content: center; margin-bottom: 10px;"> <div style="text-align: center; margin-right: 10px;"> <p>0 1 2 5</p> </div> <div style="margin-right: 10px;"> <p>SUB TOTAL</p> </div> <div> <p>Program set code No. for tax rate 1</p> </div> </div> <div style="display: flex; align-items: center; justify-content: center; margin-bottom: 10px;"> <div style="text-align: center; margin-right: 10px;"> <p>5 . 2 5</p> </div> <div style="margin-right: 10px;"> <p>= CA/AMT TEND</p> </div> <div> <p>5.25% tax rate</p> </div> </div> <div style="display: flex; align-items: center; justify-content: center; margin-bottom: 10px;"> <div style="text-align: center; margin-right: 10px;"> <p>5 0 0 3</p> </div> <div style="margin-right: 10px;"> <p>= CA/AMT TEND</p> </div> <div> <p>50 for Round off and 03 for VAT (Value Added Tax) – Add In</p> </div> </div> <div style="display: flex; align-items: center; justify-content: center; margin-bottom: 10px;"> <div style="margin-right: 10px;"> <p>SUB TOTAL</p> </div> <div> <p>Program set code No. for tax rate 2</p> </div> </div> <div style="display: flex; align-items: center; justify-content: center; margin-bottom: 10px;"> <div style="text-align: center; margin-right: 10px;"> <p>0 2 2 5</p> </div> <div style="margin-right: 10px;"> <p>SUB TOTAL</p> </div> <div> <p>10% tax rate</p> </div> </div> <div style="display: flex; align-items: center; justify-content: center; margin-bottom: 10px;"> <div style="text-align: center; margin-right: 10px;"> <p>1 0</p> </div> <div style="margin-right: 10px;"> <p>= CA/AMT TEND</p> </div> <div> <p>50 for Round off and 03 for VAT (Value Added Tax) – Add In</p> </div> </div> <div style="display: flex; align-items: center; justify-content: center; margin-bottom: 10px;"> <div style="text-align: center; margin-right: 10px;"> <p>5 0 0 3</p> </div> <div style="margin-right: 10px;"> <p>= CA/AMT TEND</p> </div> <div> <p>50 for Round off and 03 for VAT (Value Added Tax) – Add In</p> </div> </div> <div style="display: flex; align-items: center; justify-content: center;"> <div style="margin-right: 10px;"> <p>SUB TOTAL</p> </div> <div> <p>(to end the setting)</p> </div> </div> <ul style="list-style-type: none"> • See page 21 to specify the tax system and rounding for details. | <p>Setting the Tax rate</p> |
| <p>5. Press the following keys to preset tax status of departments.</p> <p>Tax status for the Departments are fixed as Non-taxable.</p> <p>Example: Set Departments 1 and 2 as taxable status 1.</p> <div style="display: flex; align-items: center; justify-content: center; margin-bottom: 10px;"> <div style="margin-right: 10px;"> <p>1 SUB TOTAL</p> </div> <div> <p>P appears in mode display</p> </div> </div> <div style="display: flex; align-items: center; justify-content: center;"> <div style="margin-right: 10px;"> <p>RA/MR + 1 - 2</p> </div> <div style="margin-right: 10px;"> <p>SUB TOTAL</p> </div> <div> <p>SUB TOTAL</p> </div> </div> <ul style="list-style-type: none"> • See page 15 to change the fixed tax status. | <p>Setting the status of Departments</p> |

| Procedure | Purpose |
|--|-------------------------|
| <p>6. For the Euro only</p> <p>6-1. Press the following keys to define the main currency/print out currency of the subtotal.</p> <div style="text-align: center;"> <p>P3 appears in mode display</p> <p>Euro Status</p> <p>(to end the setting)</p> <p>Euro status</p> <p>(1) Main currency = Local, Print out subtotal = Local: 0</p> <p>(2) Main currency = Euro, Print out subtotal = Euro: 1</p> <p>(3) Main currency = Local, Print out subtotal = Both: 2</p> <p>(4) Main currency = Euro, Print out subtotal = Both: 3</p> </div> <p>6-2. Press the following keys to set the currency exchange rate against the Euro.</p> <div style="text-align: center;"> <p>P3 appears in mode display</p> <p>Exchange rate (up to 6 digits)</p> <p>Decimal position</p> <p>(to end the setting)</p> <p>Example: (Exchange rate and decimal position)</p> <p>Currency exchange rate = 1 Euro in local currency</p> <p>1 Euro = 1.95583 DM : 1 9 5 5 8 3 5</p> </div> | <p>Setting the Euro</p> |

| Procedure | Purpose |
|---|-----------------------------------|
| <p>For Australia only.</p> <p>You can set some programmable options to suit the Australian GST by the following procedure.</p> <p>1. Insert the PROGRAM key (marked "PGM") and rotate to Z position.</p> <p>2. Press the following keys to program.</p> <div style="text-align: center;"> <p>If you want to cancel this operation, press instead of .</p> </div> | <p>Setting the Australian GST</p> |

| Procedure | Purpose |
|--|--|
| <p>For the Euro only.</p> <p>You can restrict the registrable currency to the Euro only by the following procedure.</p> <p>1. Insert the PROGRAM key (marked "PGM") and rotate to Z position.</p> <p>2. Issue all reset report including periodic data.</p> <p>3. Press the following keys to set.</p> <div style="text-align: center;"> <p>If you want to cancel this operation, press instead of .</p> </div> | <p>Restricting the currency (Euro)</p> |

5. Basic Operation after Basic Programming

Note:

Whenever an error is generated (E01 displayed), the input figures reset to 0.

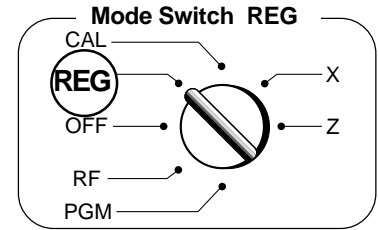

Part-1

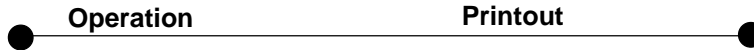

5-1 Open the drawer without a sale

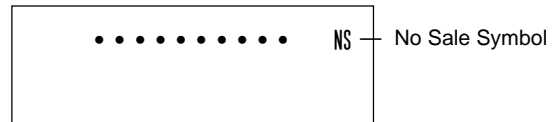

5-2 Basic operation

Example

| | |
|----------------------|--------|
| Unit Price | \$1.00 |
| Quantity | 1 |
| Dept. | 1 |
| Cash Amount tendered | \$5.00 |

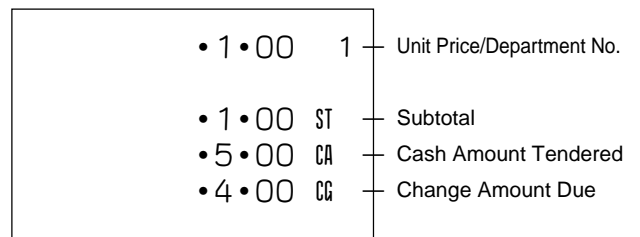
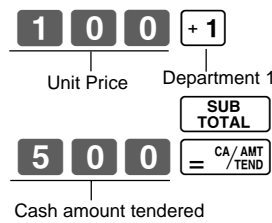

5-3 Multiple registration of the same items

Example

| | | |
|------------|--------|--------|
| Unit Price | \$1.00 | \$1.35 |
| Quantity | 2 | 3 |
| Dept. | 1 | 2 |

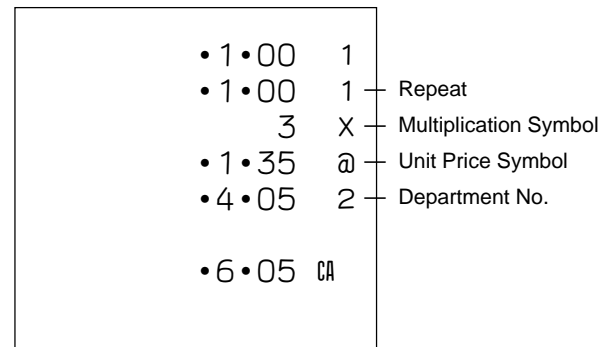
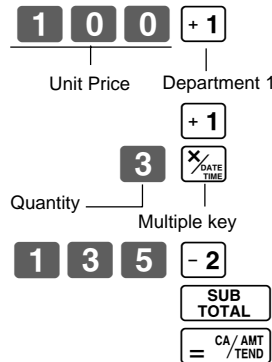

Note that repeat registration can be used with unit prices up to 6 digits long.

5-4 Charge sales

Example

| | | | |
|------------|--------|--------|--------|
| Unit Price | \$1.00 | \$2.00 | \$3.00 |
| Quantity | 1 | 1 | 1 |
| Dept. | 1 | 2 | 1 |

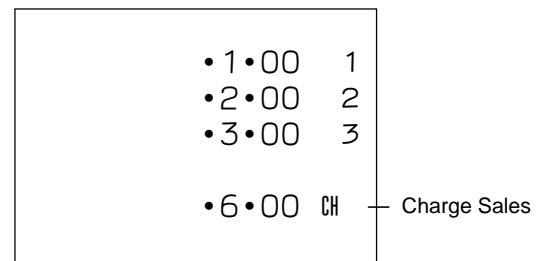
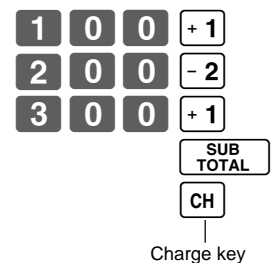

You cannot perform the amount tendered operation using the CH key.

5-5 Split cash/charge sales

Example

| | | | |
|----------------------|--------|--------|--------|
| Unit Price | \$2.00 | \$3.00 | \$4.00 |
| Quantity | 1 | 1 | 1 |
| Dept. | 1 | 2 | 1 |
| Cash Amount tendered | \$5.00 | | |

Operation

2 0 0 + 1
 3 0 0 - 2
 4 0 0 + 1
 SUB TOTAL
 5 0 0 = CA / AMT TEND
 CH

Printout

• 2.00 1
 • 3.00 2
 • 4.00 1
 • 9.00 ST
 • 5.00 CA — Cash Amount Tendered
 • 4.00 CH — Charge Sales

5-6 Corrections

Corrections can be made while you are registering the item (before you press a department key), or after it has already been registered into the memory (by pressing a department key).

5-6-1 Before you press a department key

AC C key clears the last item entered.

Example

- Entered 400 for unit price by mistake instead of 100.

Operation

4 0 0 AC C
 Wrong entry Clears the last item entered.
 1 0 0 + 1
 Correct entry Registered Department 1

Printout

• 1.00 1

- Entered unit price first instead of quantity and then pressed **X/DATE TIME**.

2 0 0 X/DATE TIME
 Unit price Multiplication
 AC C
 Clears the last item entered.
 5 X/DATE TIME
 Quantity Multiplication
 2 0 0 - 2
 Unit price Registered Department 2

5 X
 • 2.00 @
 • 10.00 2

- Entered 150 for unit price by mistake instead of 105.

1 0 X/DATE TIME
 Quantity Multiplication
 1 5 0 AC C
 Wrong entry Clears the last item entered.
 1 0 X/DATE TIME
 Quantity
 1 0 5 x 3
 Correct entry Registered Department 3

10 X
 • 1.05 @
 • 10.50 3

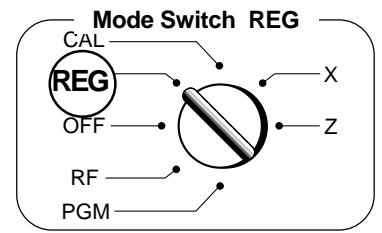

Part-1

Operation

Printout

5-6-2 After you pressed a department key

ERR CORR key cancels the last registered item.

Example

- Entered unit price 550 by mistake instead of 505 and pressed a department key.

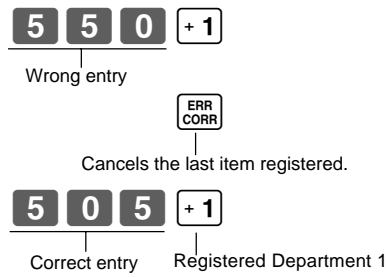

| | |
|-------|----|
| •5•50 | 1 |
| -5•50 | VD |
| •5•05 | 1 |

- Entered unit price 220 by mistake instead of 230 and pressed a department key.

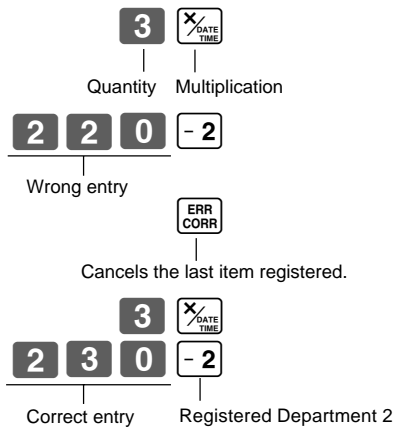

| | |
|-------|----|
| 3 | X |
| •2•20 | @ |
| •6•60 | 2 |
| -6•60 | VD |
| 3 | X |
| •2•30 | @ |
| •6•90 | 2 |

5-7-1 Registering with currency exchange

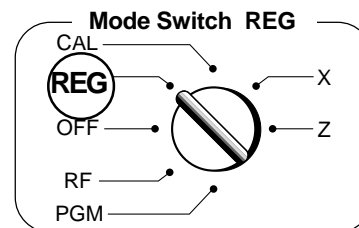

Example

| | |
|----------------------|-----------------|
| Unit Price | 2.00 |
| Quantity | 3 |
| Dept. | 1 |
| Cash Amount Tendered | Euro 15.00 |
| Rate | 1Euro = 0.5 Fr |
| Main currency | Local (Fr) |
| Printout of ST | Both currencies |

| Operation | Display |
|---|----------------------|
| <p>3 </p> <p>2 0 0 </p> <p></p> <p></p> <p>Pressing before subtotal converts the subtotal amount into the Euro.</p> | <p>12.00E</p> |
| <p>1 5 0 0 </p> <p>Pressing after amount tendered converts the amount into the Euro. *1</p> | <p>15.00E</p> |
| <p></p> <p>Press to finalize the transaction. The change amount in the main currency is shown on the display. *2</p> | <p>1.50</p> |
| <p></p> <p>You can switch the currency of change amount repeatedly by pressing the key.</p> | <p>3.00E</p> |

- *1 If the payment is the same as the subtotal amount, you can omit this operation. Press key directly after the subtotal.
- *2 If the payment is less than the subtotal amount, the cash register specifies it as a partial payment and shows the balance in the main currency on the display.

Printout

| | |
|----------|-------------------------------|
| 3 X | |
| •2.00 @ | |
| •6.00 1 | |
| •6.00 ST | Subtotal in the main currency |
| 12.00 @ | Subtotal after conversion |
| 15.00 CA | Payment in the Euro |
| @ | |
| •7.50 CA | Payment after conversion |
| •1.50 CA | Change in the main currency |
| 3.00 @ | Change in the sub currency |

6. Daily Management Report

This section tells you the procedures to use to produce reports of the transaction data stored in the cash register's memory.

Important

Remember that when you issue a reset (Z) report, the data that is reported is cleared from the applicable totalizers. To view data without clearing totalizers, issue a read (X) report.

6-1 Financial Report

Operation

Printout

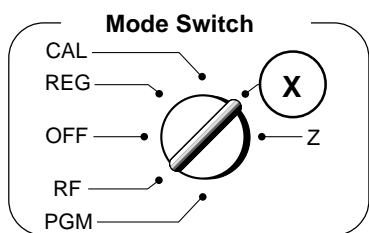

| | |
|----------------|----------------------------|
| 08-01-02 | Date |
| 12-35#0085 | Time/Consecutive No. |
| X | Read Symbol |
| 158 * | Gross Sales No. of items |
| • 16676•48 * | Gross Sales Amount |
| 46 NT | Net Sales No. of Customers |
| • 16675•99 NT | Net Sales Amount |
| • 16518•99 CA# | Cash Total in Drawer |
| • 92•00 CH# | Charge Total in Drawer |
| • 70•00 *CK | Check Total in Drawer |

6-2 General Control Read/Reset Report

Operation

Printout

6-2-1 Daily Read/Reset Report

Mode Switch to **X**
(Read)



Z (Reset) report

| | |
|--------------|--|
| 08-01-02 | Date |
| 19-35#0086 | Time/Consecutive No. |
| 0001 Z | Non-resettable No. of Resets/RESET Symbol ** |
| 48 1 | No. of Items/Dept. No. |
| • 166•94 | Amount |
| 61 2 | |
| • 1259•15 | |
| 44 3 | |
| • 15175•39 | |
| 5 4 | |
| • 75•00 | |
| 158 * | Gross Sales No. of Items |
| • 16676•48 * | Gross Sales Amount |

Mode Switch to **Z**
(Reset)



| | | |
|------------|------|---|
| • 1•40 | - | Reduction Amount |
| • 0•91 | %+ | Premium/Discount Amount |
| • 1182•64 | TA | Taxable Amount for Tax Rate 1 |
| • 62•07 | TX | Tax Amount for Tax Rate 1 |
| • 167•45 | *TA | Taxable Amount for Tax Rate 2 |
| • 16•75 | TX2 | Tax Amount for Tax Rate 2 |
| 46 | NT | Net Sales No. of Customers |
| • 16675•99 | NT | Net Sales Amount |
| 47 | CA | Cash Sales Count |
| • 16513•99 | CA | Cash Sales Amount |
| 4 | CH | Charge Sales Count |
| • 92•00 | CH | Charge Sales Amount |
| 1 | CK | Check Sales Count |
| • 70•00 | CK | Check Sales Amount |
| • 15•00 | RA | Received On Account Amount |
| • 10•00 | PO | Paid Out Amount |
| 4 | VD | Error Correction Count |
| 1 | RF | Refnd Mode Count |
| • 3•00 | RF | Refund Mode Amount |
| 16 | CA X | No. of <input type="checkbox"/> CA/ <input type="checkbox"/> AMT/ <input type="checkbox"/> TEND key operation |
| 1 | NS | No sale Count |
| • 16518•99 | CA # | Cash in Drawer |
| • 92•00 | CH # | Charge in Drawer |
| • 70•00 | *CK | Check in Drawer |
| 000001 | | Non-resettable Grand Sales total |
| 6675•99 | | (Printed only on RESET report) ² |

X (Read) report is the same except ¹ and ².

6-2-2 Periodic Read/Reset Report

Operation

Printout

Mode Switch to

Z

or

X

1

0

CA/ AMT/ TEND

| | | |
|------------|----|----------------------------|
| 08-01-02 | | Date |
| 19-50#0087 | | Time/Consecutive No. |
| # 10#•••• | X | Read Symbol |
| 77 | * | Gross Sales No. of Items |
| • 1116•90 | * | Gross Sales Amount |
| 11 | NT | Net Sales No. of Customers |
| • 1116•90 | NT | Net Sales Amount |



CONVENIENT OPERATION

1. Various Programming

1-1 Unit price for Departments

Example

| | | | |
|------------|--------|--------|---------|
| Unit Price | \$1.00 | \$2.20 | \$11.00 |
| Dept. | 1 | 2 | 3 |

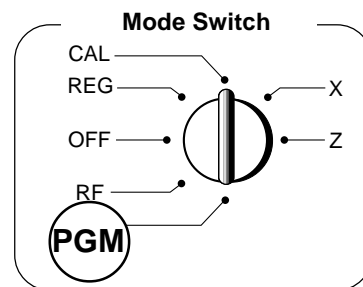
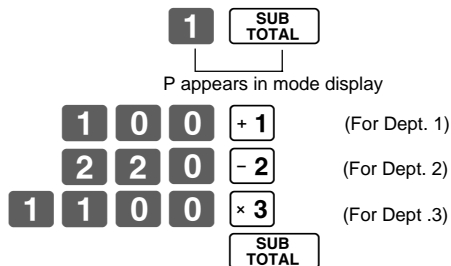

Part-2

- Unit prices within the range of 0.01~9999.99.

1-2 Rate for percent key

Example

| | |
|---------------|------|
| Discount Rate | 2.5% |
|---------------|------|

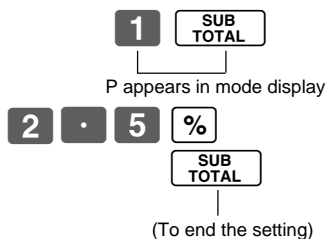

- The rate within the range of 00.01 to 99.99%.

1-3 To change tax status for Departments

Tax status for the Departments 1~4 are initialized as Non-Taxable.

Example

| | | |
|--------|-----------|-----------|
| Status | Taxable 1 | Taxable 2 |
| Depts. | 1 | 2 |

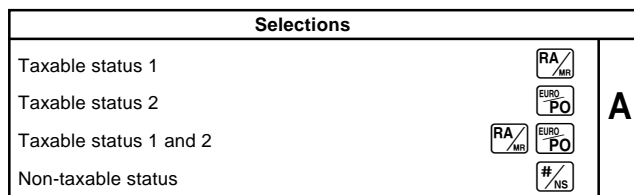
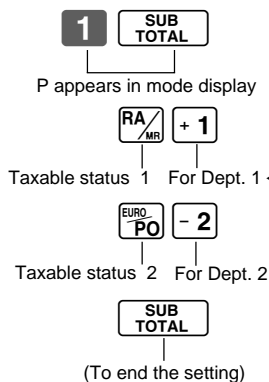

1-4 Status for Department

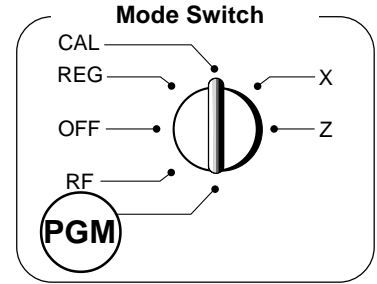

Example

| Depts. | Selections | | |
|--------|------------|---|---|
| | A | B | C |
| 1 | 0 | 4 | 1 |
| 2 | 0 | 5 | 1 |

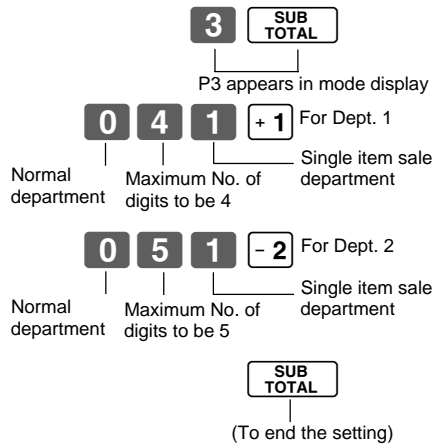

| Selections | | |
|---|--------|---|
| Normal department | 0 | A |
| Minus department | 1 | |
| No limitation for manually entered price. | 0 | B |
| Maximum number of digits for manually entered price (1 ~ 7 digits). | 1 ~ 7 | |
| To prohibit manual price entries. | 8 or 9 | |
| Normal sale (not a single-item sale) department. | 0 | C |
| Set as a single-item sale department. | 1 | |

1-5 Status for percent key

1-5-1 To change taxable status for the percent key

The percent key is initialized as Non-taxable.

Example

Change Percent key registration as a Taxable status 1.

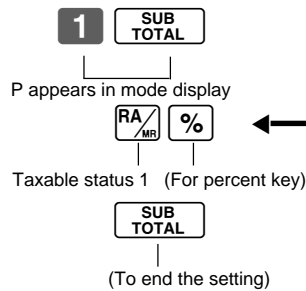

| Selections | | |
|------------------------|---------------|---|
| Taxable status 1 | RA/MR | A |
| Taxable status 2 | EURO PO | |
| Taxable status 1 and 2 | RA/MR EURO PO | |
| Non-taxable status | #/NS | |

1-5-2 Status for percent key

Example

| | |
|---------|----|
| Round | Up |
| Percent | %+ |

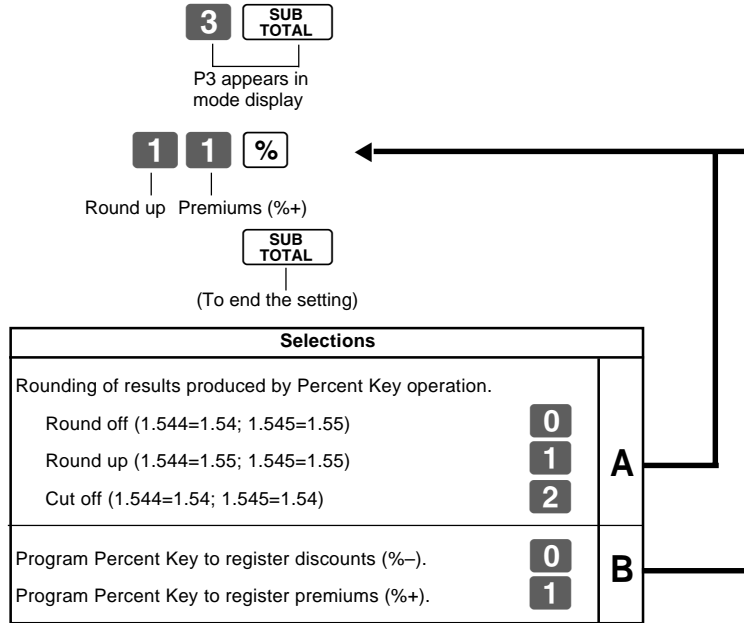

Part-2

1-6 Taxable Status for minus key

Example :

Change minus key registrations
Taxable status 1.

The minus key is initialized as Non-taxable.

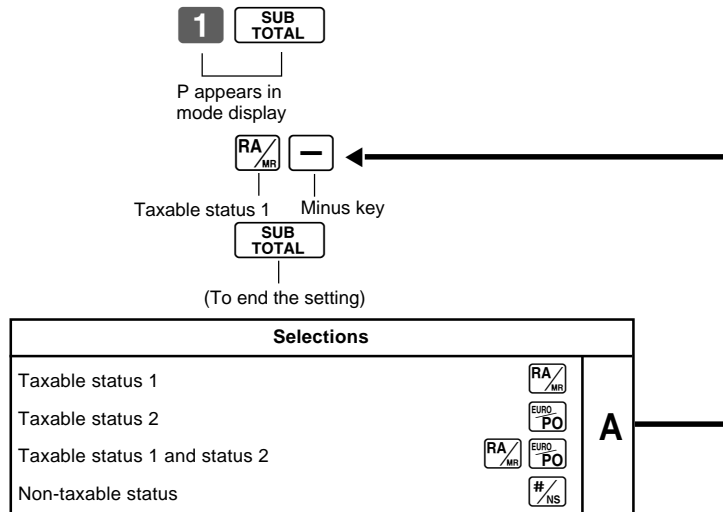

1-7 General features

1-7-1 To set general controls

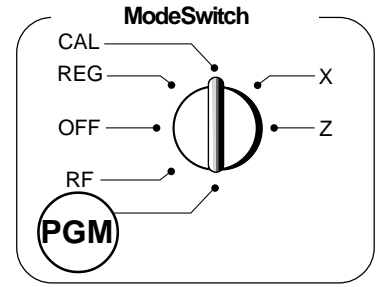
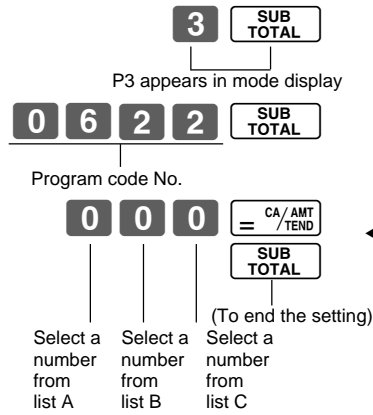

| Selections | | | |
|---|-----|-----|---|
| Maintain key buffer during receipt issue in REG mode. | | | |
| Reset the transaction number to zero whenever a General Control Reset Report is issued. | | | |
| Allow credit balance registration. | | | |
| No | Yes | Yes | 0 |
| | | No | 1 |
| | No | Yes | 2 |
| | | No | 3 |
| Yes | Yes | Yes | 4 |
| | | No | 5 |
| | No | Yes | 6 |
| | | No | 7 |

| Selections | | | |
|--|-----|-----|---|
| Limit the last 2 digits of cash amount tendered to 00, 25, 50 and 75 when Denmark rounding is specified for subtotal and total amount. | | | |
| Allow partial cash amount tendered. | | | |
| Allow partial check amount tendered. | | | |
| Yes | Yes | No | 0 |
| | | Yes | 1 |
| | No | No | 2 |
| | | Yes | 3 |
| No | Yes | No | 4 |
| | | Yes | 5 |
| | No | No | 6 |
| | | Yes | 7 |

| Selections | |
|---------------------------------------|---|
| Use the 00 key on a numeric keyboard. | 0 |
| Use the 00 key as a 000 key. | 1 |

1-7-2 To set printing controls

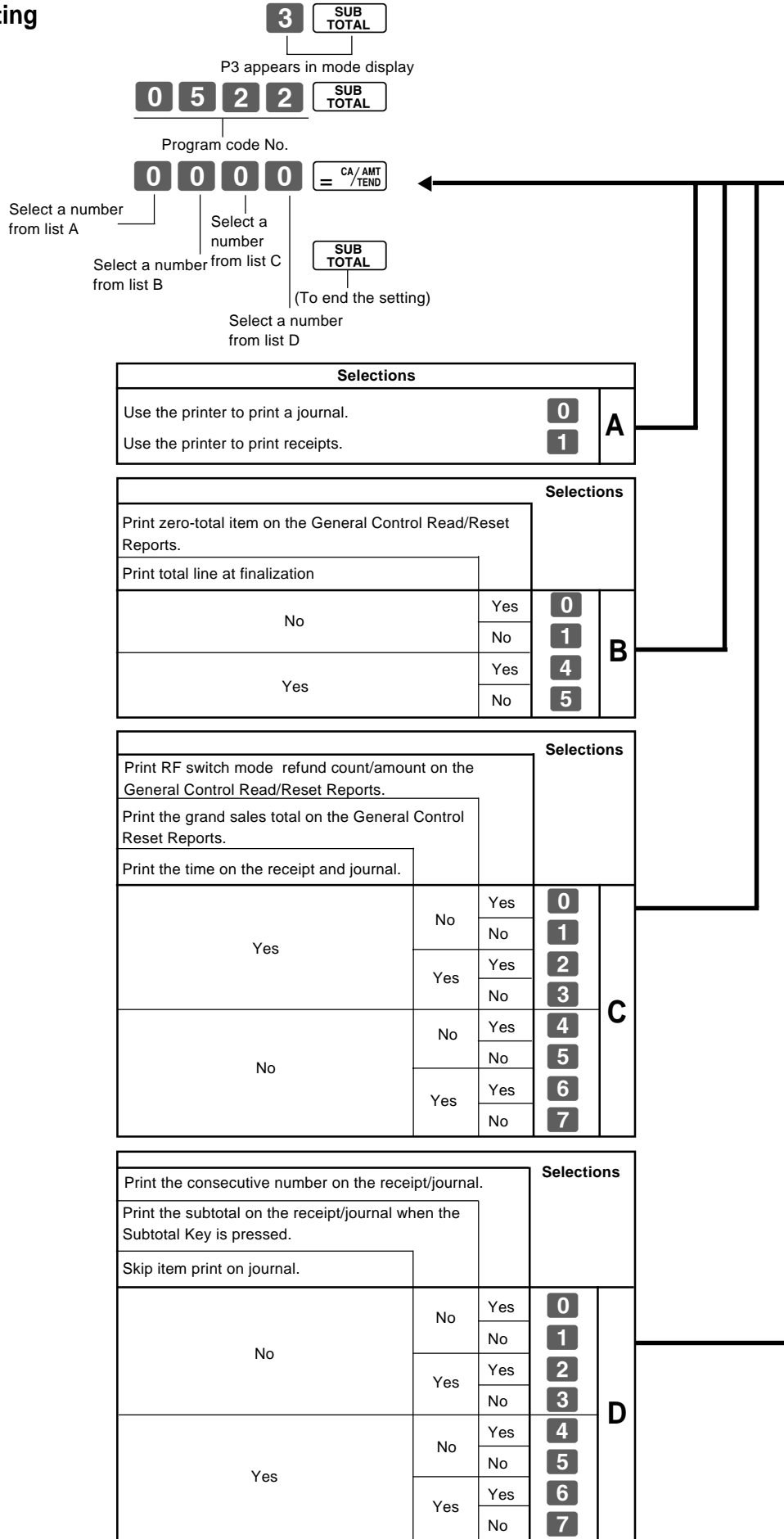

Part-2

1-7-3 Printer switch for Receipt or Journal

The printer is initialized as journal.

Example

To print a receipt

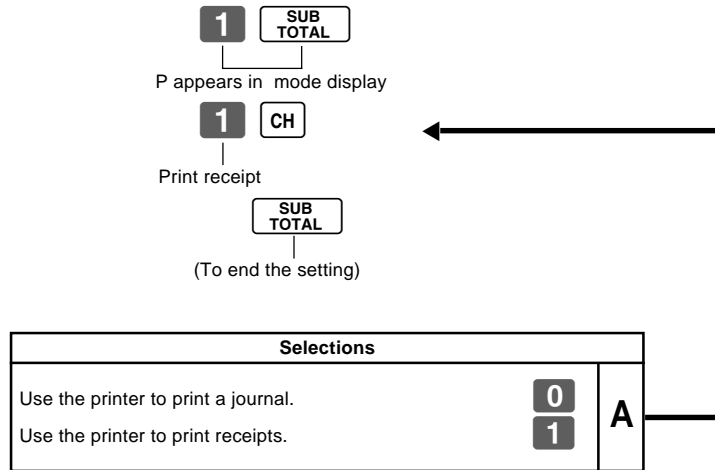
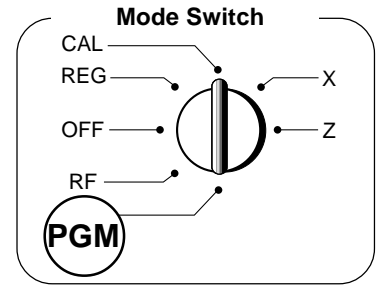

- Printer selection to print a journal or receipts can also be set on procedures 1-7-2 "To set printing controls".

1-8 Setting the Tax Rate and rounding

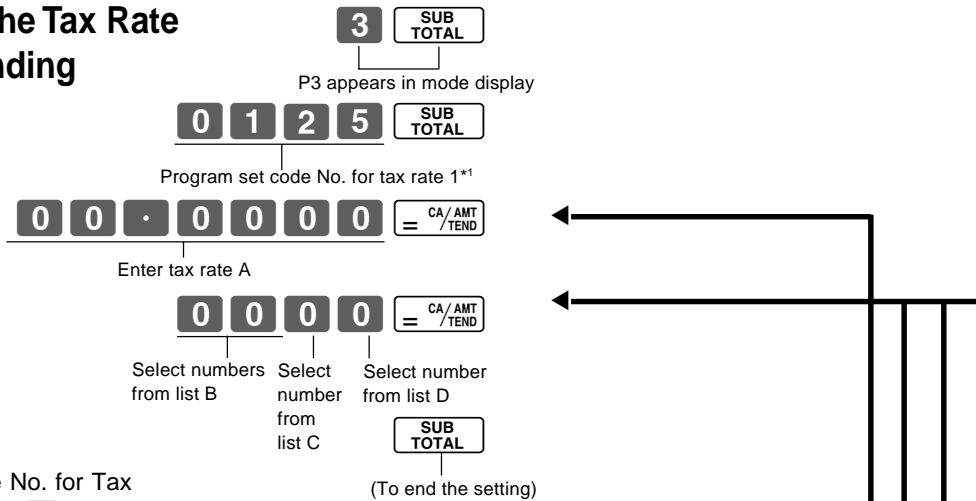

*1 Program set code No. for Tax rate 2 is 0 2 2 5.

- You can use either an add-on rate tax or an add-in rate tax (VAT), depending on the requirements in your area. You can specify only one tax rate.
- The normal rounding specification tells the cash register how to round tax amounts to the proper number of decimal places.
- The special rounding specification and Denmark rounding tell the cash register how to round off subtotals and totals so that their rightmost 2 digits are 00, 25, 50 and 75.
- Note that the rounding specification you program for your cash register depends on the tax laws of your country.

| Tax rate specifications | |
|---|------------|
| The tax rate within the range of 0.0001 ~ 99.9999%. Use . key for decimal point. | A |
| Normal rounding specifications | |
| Cut off to 2 decimal places. (1.544=1.54; 1.545=1.54) | 0 0 |
| Round off to 2 decimal places. (1.544=1.54; 1.545=1.55) | 5 0 |
| Round up to 2 decimal places. (1.544=1.55; 1.545=1.55) | 9 0 |
| B | |
| Special rounding specifications for subtotal and total amounts | |
| No specifications | 0 |
| Special rounding 1 0 ~ 2 → 0; 3 ~ 7 → 5; 8 ~ 9 → 10 Examples: 1.21=1.20; 1.26=1.25; 1.28=1.30 | 1 |
| Special rounding 2 0 ~ 4 → 0; 5 ~ 9 → 10 Examples: 1.123=1.120; 1.525=1.530 | 2 |
| Denmark rounding (set the amount tender restriction on page 18 also) 00 ~ 12 → 0; 13 ~ 37 → 25; 38 ~ 62 → 50; 63 ~ 87 → 75; 88 ~ 100 → 100 Examples: 1.11=1.00; 1.28=1.25; 1.39=1.50; 1.80=1.75; 1.99=2.00 | 3 |
| C | |
| Scandinavian rounding | 6 |
| 00 ~ 24 → 0; 25 ~ 74 → 50; 75 ~ 99 → 100 Examples: 1.21=1.0; 1.30=1.50; 1.87=2.00 | |
| Australian rounding (only for tax rate 1) | 7 |
| 0 ~ 2 → 0; 3 ~ 7 → 5; 8 ~ 9 → 10 Examples: 1.21=1.20; 1.26=1.25; 1.28=1.30 | |
| Tax system specifications for subtotal and total amounts | |
| No specifications. | 0 |
| Specifies add-on rate tax. | 2 |
| Specifies add-in rate tax (VAT). | 3 |
| D | |

Part-2

1-9 To control Tax Status printing

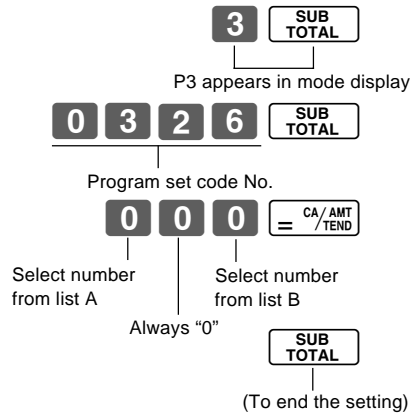
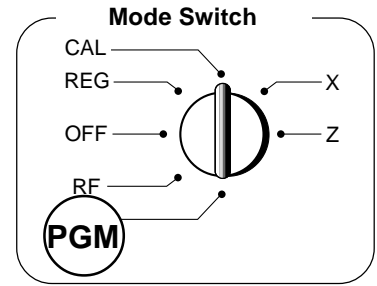

| | | Selections | |
|--|-----|------------|---|
| Print tax total line (only for Australia). | | | |
| Print tax symbol (only for Australia). | | | |
| Yes | No | 0 | A |
| | Yes | 1 | |
| No | No | 2 | |
| | Yes | 3 | |

| | | Selections | |
|---|-----|------------|---|
| Print taxable amount. | | | |
| Print taxable amount and tax amount for Add-in. | | | |
| Yes | Yes | 0 | B |
| | No | 1 | |
| No | Yes | 2 | |
| | No | 3 | |

1-10 Printing to read All Pre-set Data

- Printing preset data.

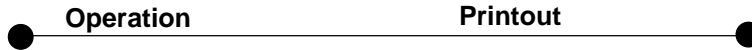

CA/AMT
TEND

| | | |
|--------------|---|-------------------------------------|
| 08-01-02 | | Date |
| 08-06#0038 | | Time/Consecutive No. |
| | X | Read Symbol |
| 1.....1.00 | 1 | Dept No./Unit Price/Tax Status |
| #041 | | Normal Dept/Digit Limit/Single Item |
| 2.....2.20 | 2 | |
| #051 | | |
| 3.....11.00 | # | |
| #000 | | |
| -..... | 1 | Minus/Tax Status |
| 2.5 % | | Percent Rate/%+ or %- |
| #11 | 1 | Percent Key Control/Tax Status |
| 1.23242 | # | Euro Exchange Rate |
| 0122...#22 | | Date/Monetary Mode Control |
| 0522...#1062 | | Print Control |
| 0622...#0000 | | General Control |
| 1022...#3 | | Calculation Control |
| 0326...#002 | | Tax Control |
| 2422...#0 | | Euro Status |
| 0125..... | | |
| 5.2500 % | | Tax Rate1 |
| 5003 | | Rounding specification/ |
| 0000 | | Tax System specification |
| 0255..... | | |
| 10.0000 % | | Tax Rate 2 |
| 5003 | | |
| 0000 | | |
| 08-01-01 | | |

Part-2

2. Various Operations

2-1 Registration using preset price for Departments.

(Programming: See page 15)

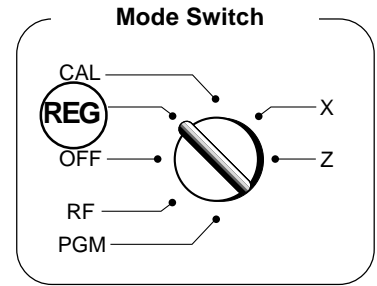

Example

| | | | |
|-----------------|---------|--------|---------|
| Unit Price | \$1.00 | \$2.20 | \$11.00 |
| Quantity | 1 | 2 | 4 |
| Depts. | 1 | 2 | 3 |
| Amount tendered | \$50.00 | | |

| Operation | Printout | | | | | | | | | | | | | | | | | | | | | | | | | | | |
|---|--|---------------------------------------|---|---------------------------------------|--------|---|---------------------------------------|--------|---|--------|---|---|-----------------------|---------|---|---------------------------------------|---------|---|--|---------|----|--|---------|----|----------------------|--------|----|--------|
| <p style="text-align: center;">+ 1</p> <p style="text-align: center;">- 2</p> <p style="text-align: center;">- 2</p> <p style="text-align: center;">4 X DATE THIS x 3</p> <p style="text-align: center;">SUB TOTAL</p> <p style="text-align: center;">5 0 0 0 = CA/AMT TEND</p> | <table border="1" style="width: 100%;"> <tr> <td style="text-align: right;">• 1•00</td> <td style="text-align: right;">1</td> <td>Unit Price Programmed to Department 1</td> </tr> <tr> <td style="text-align: right;">• 2•20</td> <td style="text-align: right;">2</td> <td>Unit Price Programmed to Department 2</td> </tr> <tr> <td style="text-align: right;">• 2•20</td> <td style="text-align: right;">2</td> <td>Repeat</td> </tr> <tr> <td style="text-align: right;">4</td> <td style="text-align: right;">X</td> <td>Multiplication Symbol</td> </tr> <tr> <td style="text-align: right;">• 11•00</td> <td style="text-align: right;">@</td> <td>Unit Price Programmed to Department 3</td> </tr> <tr> <td style="text-align: right;">• 44•00</td> <td style="text-align: right;">3</td> <td></td> </tr> <tr> <td style="text-align: right;">• 49•40</td> <td style="text-align: right;">ST</td> <td></td> </tr> <tr> <td style="text-align: right;">• 50•00</td> <td style="text-align: right;">CA</td> <td>Cash Amount Tendered</td> </tr> <tr> <td style="text-align: right;">• 0•60</td> <td style="text-align: right;">CG</td> <td>Change</td> </tr> </table> | • 1•00 | 1 | Unit Price Programmed to Department 1 | • 2•20 | 2 | Unit Price Programmed to Department 2 | • 2•20 | 2 | Repeat | 4 | X | Multiplication Symbol | • 11•00 | @ | Unit Price Programmed to Department 3 | • 44•00 | 3 | | • 49•40 | ST | | • 50•00 | CA | Cash Amount Tendered | • 0•60 | CG | Change |
| • 1•00 | 1 | Unit Price Programmed to Department 1 | | | | | | | | | | | | | | | | | | | | | | | | | | |
| • 2•20 | 2 | Unit Price Programmed to Department 2 | | | | | | | | | | | | | | | | | | | | | | | | | | |
| • 2•20 | 2 | Repeat | | | | | | | | | | | | | | | | | | | | | | | | | | |
| 4 | X | Multiplication Symbol | | | | | | | | | | | | | | | | | | | | | | | | | | |
| • 11•00 | @ | Unit Price Programmed to Department 3 | | | | | | | | | | | | | | | | | | | | | | | | | | |
| • 44•00 | 3 | | | | | | | | | | | | | | | | | | | | | | | | | | | |
| • 49•40 | ST | | | | | | | | | | | | | | | | | | | | | | | | | | | |
| • 50•00 | CA | Cash Amount Tendered | | | | | | | | | | | | | | | | | | | | | | | | | | |
| • 0•60 | CG | Change | | | | | | | | | | | | | | | | | | | | | | | | | | |

2-2 Single-Item Sales

(Programming: See page 16)

Example 1:

| | |
|------------|------------------|
| Status | Single item sale |
| Unit Price | \$0.50 |
| Quantity | 1 |
| Dept. | 1 |

| | | | | | | | |
|--|---|------------|---|--|--------|----|------------|
| <p style="text-align: center;">5 0 + 1</p> | <table border="1" style="width: 100%;"> <tr> <td style="text-align: right;">• 0•50</td> <td style="text-align: right;">1</td> <td></td> </tr> <tr> <td style="text-align: right;">• 0•50</td> <td style="text-align: right;">CA</td> <td>Cash Sales</td> </tr> </table> | • 0•50 | 1 | | • 0•50 | CA | Cash Sales |
| • 0•50 | 1 | | | | | | |
| • 0•50 | CA | Cash Sales | | | | | |

For this example, Dept. 1 is programmed for a single-item-sale. (Programming: See page 16.)

Example 2:

| | | |
|------------|--------|------------------|
| Status | Normal | Single item sale |
| Unit Price | \$1.00 | \$0.50 |
| Quantity | 1 | 1 |
| Dept. | 2 | 1 |

| | | | | | | | | | | |
|---|---|------------|---|--|--------|---|--|--------|----|------------|
| <p style="text-align: center;">1 0 0 - 2</p> <p style="text-align: center;">5 0 + 1</p> <p style="text-align: center;">SUB TOTAL</p> <p style="text-align: center;">= CA/AMT TEND</p> | <table border="1" style="width: 100%;"> <tr> <td style="text-align: right;">• 1•00</td> <td style="text-align: right;">2</td> <td></td> </tr> <tr> <td style="text-align: right;">• 0•50</td> <td style="text-align: right;">1</td> <td></td> </tr> <tr> <td style="text-align: right;">• 1•50</td> <td style="text-align: right;">CA</td> <td>Cash Sales</td> </tr> </table> | • 1•00 | 2 | | • 0•50 | 1 | | • 1•50 | CA | Cash Sales |
| • 1•00 | 2 | | | | | | | | | |
| • 0•50 | 1 | | | | | | | | | |
| • 1•50 | CA | Cash Sales | | | | | | | | |

Single-item sale cannot be finalized if an item is registered previously.

2-3 Check sales

Example:

| | |
|------------|---------|
| Unit Price | \$35.00 |
| Quantity | 2 |
| Dept. | 4 |

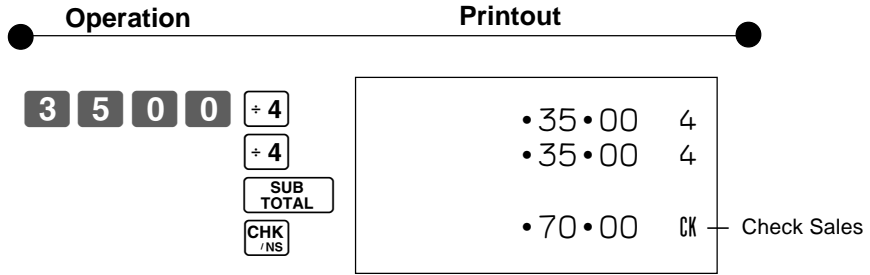

2-4 Split cash/ check sales

Example:

| | | |
|----------------------|---------|---------|
| Unit Price | \$30.00 | \$25.00 |
| Quantity | 1 | 1 |
| Depts. | 2 | 3 |
| Cash amount tendered | \$20.00 | |
| Check | \$35.00 | |

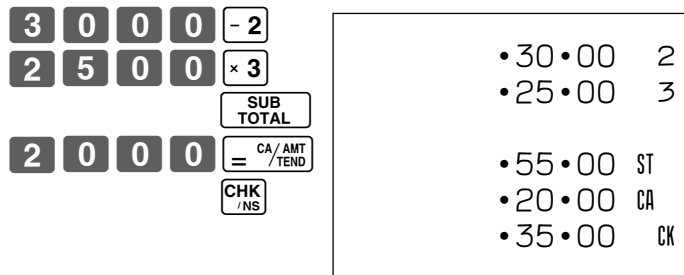

Part-2

Mode Switch

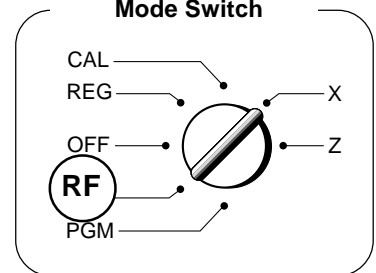

2-5 Refund

Example

| | | |
|------------|--------|--------|
| Unit Price | \$1.00 | \$2.00 |
| Quantity | 1 | 1 |
| Dept. | 2 | 3 |

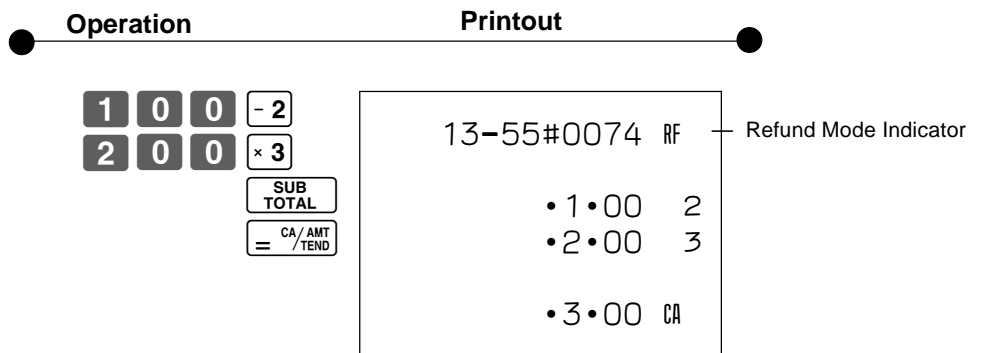

After you finish RF mode operation, be sure to return the Mode Switch to the REG (register) setting.

Mode Switch

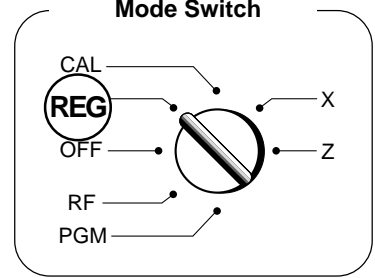

2-6 Other registrations

2-6-1 Reading the Time and Date

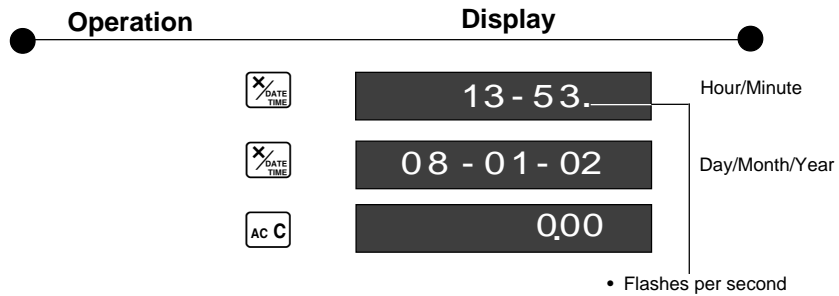

2-6-2 Paid out from cash in drawer

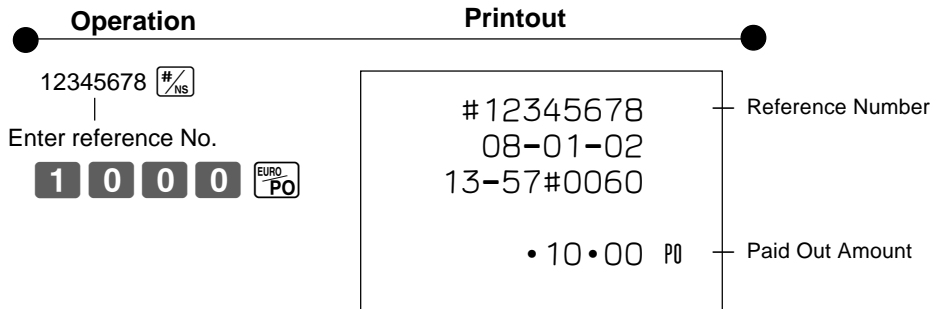

2-6-3 Cash received on account

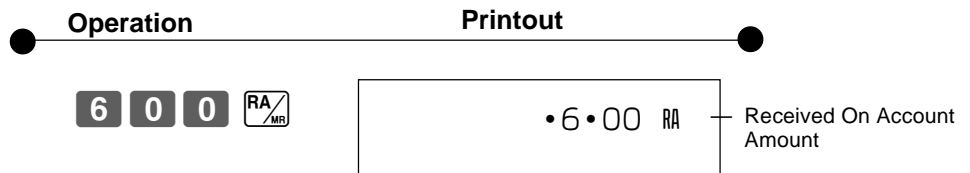

2-6-4 Registering identification numbers

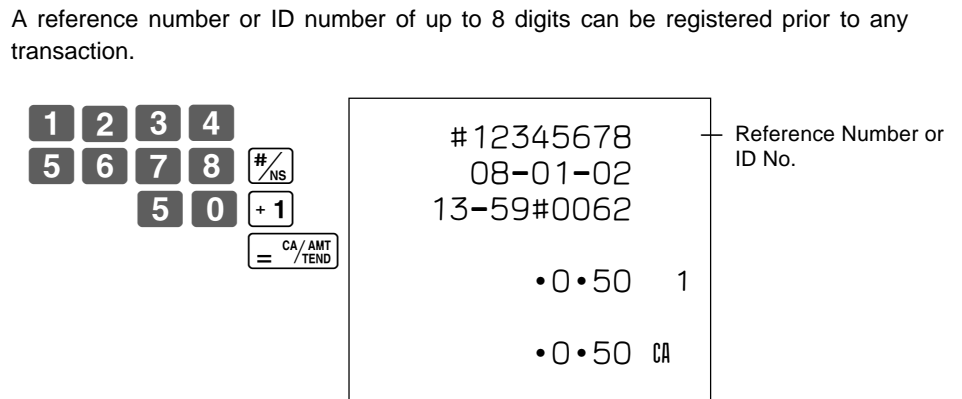

2-6-5 Reduction on subtotal

Example:
Amount due reduced by \$0.50.

| Operation | Printout |
|----------------|-----------|
| 1 0 0 + 1 | • 1.00 1 |
| 2 0 0 ÷ 4 | • 2.00 4 |
| SUB TOTAL | - 0.50 |
| 5 0 - | |
| = CA/AMT /TEND | • 2.50 CA |

2-6-6 Premium/Discount

- 2.5% premium/discount (programmed to [%] key) applied to first item.

1 0 0 + 1
%
2 0 0 - 2
3 0 0 + 1
SUB TOTAL
7 %
= CA/AMT /TEND

- 7% premium/discount applied to transaction total.
- For programming the [%] key as percent minus or percent plus, see page 17.
- For programming percent rate, see page 15.

| Premium | Discount | |
|-----------|-----------|-------------------------|
| • 1.00 1 | • 1.00 1 | Premium/Discount Rate |
| 2.5 % | 2.5 % | Premium/Discount Amount |
| • 0.03 | - 0.03 | |
| • 2.00 2 | • 2.00 2 | |
| • 3.00 1 | • 3.00 1 | |
| • 6.23 ST | • 5.97 ST | Subtotal |
| 7 % | 7 % | Premium/Discount Rate |
| • 0.43 | - 0.42 | Premium/Discount Amount |
| • 6.46 CA | • 5.55 CA | |

Part-2

2-7 About the daylight saving time

It is possible to set the internal clock forward/backward by 1~9 hour(s) for the daylight saving time.

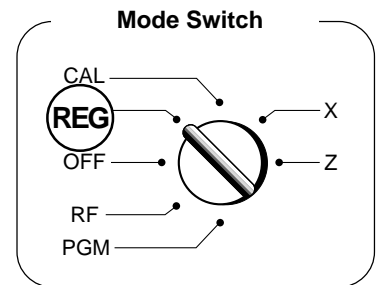

| Operation | Display |
|----------------------|---------------------------------|
| • Forward by 1 hour | 12 - 34 |
| * 1 | 12 - 34 (blinking) |
| X/DATE TIME | 13 - 34 Set forward by 1 hour. |
| AC C | 0.00 |
| • Backward by 1 hour | 12 - 34 |
| - 2 | 12 - 34 (blinking) |
| * 1 | 12 - 34 (blinking) |
| X/DATE TIME | 11 - 34 Set backward by 1 hour. |
| AC C | 0.00 |

*Put [2] ~ [9], in case of set the clock by 2~9 hours.

Part 3

CALCULATOR FUNCTION

1. Calculator Mode

While registering at REG mode, you can switch to CAL mode and then return to REG mode to resume the registration.

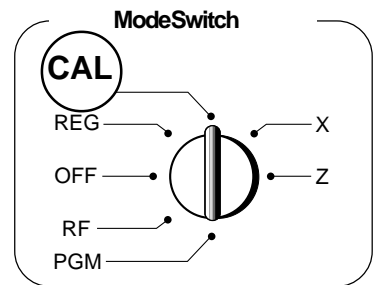

1-1 Calculation examples

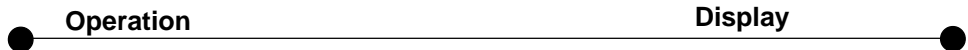

5+3-2=

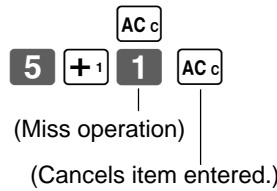

(23-56)×78=



(4×3-6)÷3.5+8=

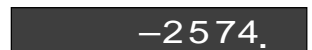

12% on 1500

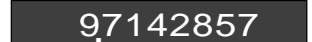

1-2 Memory recall

Recalls the current amount onto the display.

- during registration: current subtotal
- registration has been completed: the last amount

On CAL mode



Example:

Divide the current subtotal \$30.00 at REG mode by 3 (to divide the bill between 3 people).



Memory recall



On REG mode

Recalls the current result by pressing [= CA/AMT/TEND] key at CAL mode on the display.

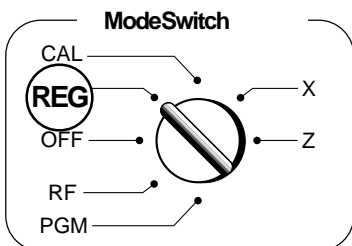

Example:

Recall the current result at CAL mode during registration, and register the cash amount due for each person.

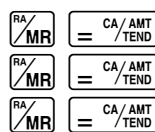
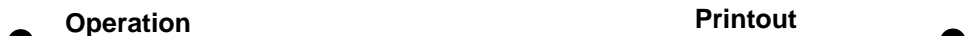

Memory recall

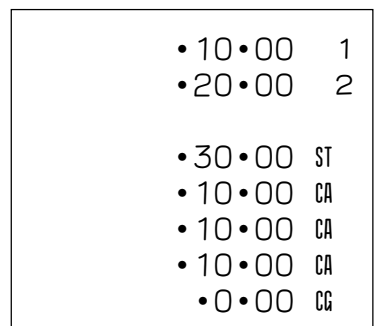

1-3 Setting for calculator operation

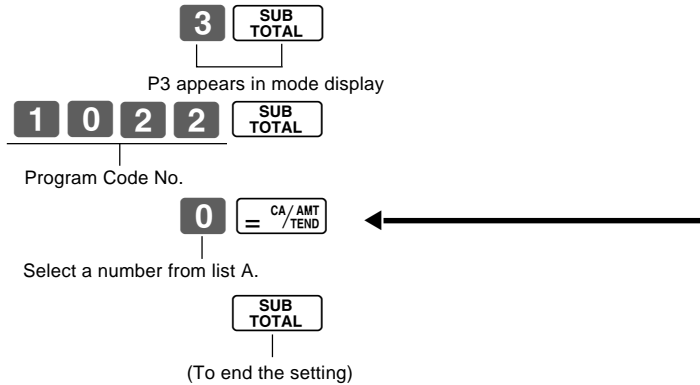
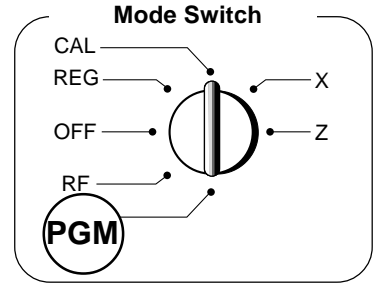

| | | | Selections | |
|---|-----|-----|------------|----------|
| Open drawer whenever is pressed.* | | | | |
| Open drawer whenever is pressed. | | | | |
| Print No. of Equal key operations on General Control X and Z reports. | | | | |
| Yes | No | No | 0 | A |
| | | Yes | 1 | |
| | Yes | No | 2 | |
| | | Yes | 3 | |
| No | No | No | 4 | |
| | | Yes | 5 | |
| | Yes | No | 6 | |
| | | Yes | 7 | |

* Drawer does not open during registration procedures even if you press by turning the mode switch to CAL position.

1. Troubleshooting

| | Symptom/Problem | Most common causes | Solutions |
|---|--|---|--|
| 1 | E01 appears on the display. | Changing modes without completing transaction. | Return key to where it stops buzzing and press  . |
| 2 | E94 appears on the display. | Printer paper is jammed. | Remove jammed paper. Turn Mode switch to OFF then turn to ON, or Turn power OFF and then turn power ON. |
| 3 | No date or time on receipt. Paper is not advancing enough. | Printer is programmed as a journal. | Program printer to print receipts. |
| 4 | Key won't turn to Z, X, PGM and RF modes. | Using OP key. | Use the PGM key. |
| 5 | Drawer opens up after ringing up only one time. | Department is programmed as a single item dept. | Program the dept. as a normal dept. |
| 6 | Not clearing totals at end of day after taking report. | Using X mode to take out reports. | Use Z mode to take out reports. |
| 7 | Programming is lost whenever register is unplugged or there is a power outage. | Bad or no batteries. | Put in new batteries. |
| 8 | Register is inoperative. Can't get money out of drawer. | No power. | Pull lever underneath register at rear. |

When the cash drawer does not open!

In case of power failure or the machine is in malfunction, the cash drawer does not open automatically. Even in these cases, you can open the cash drawer by pulling drawer release lever (see below).

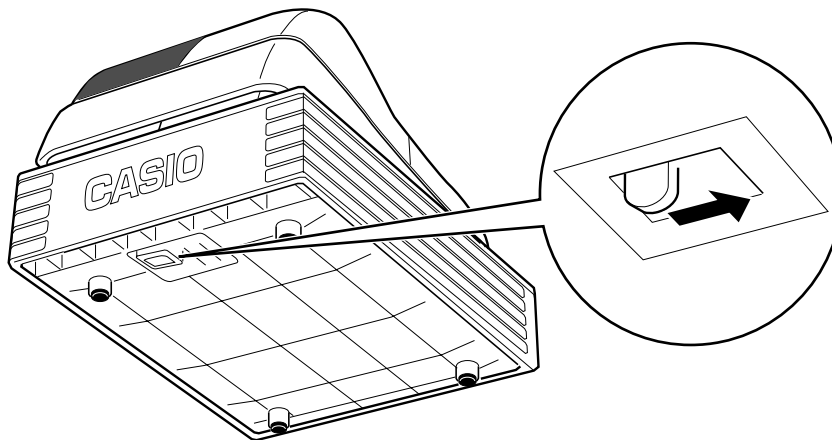

Important!

The drawer will not open, if it is locked with a drawer lock key.

2. Specifications

INPUT METHOD

Entry: 10-key system; Buffer memory 6 keys (2-key roll over)
 Display (Digitron): Amount 8 digits (zero suppression); Department No.; No. of repeats; TOTAL; CHANGE

PRINTER

Receipt: 12 digits (Amount 10 digits, Symbol 2 digits)
 (or journal) Automatic paper roll winding (journal)
 Paper roll: 58 mm × 80 mm Ø (Max.)

CALCULATIONS

Entry 8 digits; Registration 7 digits; Total 8 digits

CALCULATOR FUNCTION

8 digits; Arithmetic calculations; Percent calculations

Memory protection batteries:

The effective service life of the memory protection batteries (3 UM-3, R6P (SUM-3) or LR6 (AM-3) type batteries) is approximately one year from installation into the machine.

Power source/Power consumption: See the rating plate.

Operating temperature: 0°C to 40°C (32°F to 104°F)

Humidity: 10 to 90%

Dimensions/Weight: 254 mm(H)× 330 mm(W)× 450 mm(D) with S drawer
 5.5 kg with S drawer
 270 mm(H)× 410 mm(W)× 450 mm(D) with M drawer
 8.5 kg with M drawer

Specifications and design are subject to change without notice.

The main plug on this equipment must be used to disconnect mains power. Please ensure that the socket outlet is installed near the equipment and shall be easily accessible.



Casio Electronics Co., Ltd.
 Unit 6, 1000 North Circular Road
 London NW2 7JD, U.K.

Please keep all information for future reference.

To open the multipurpose tray

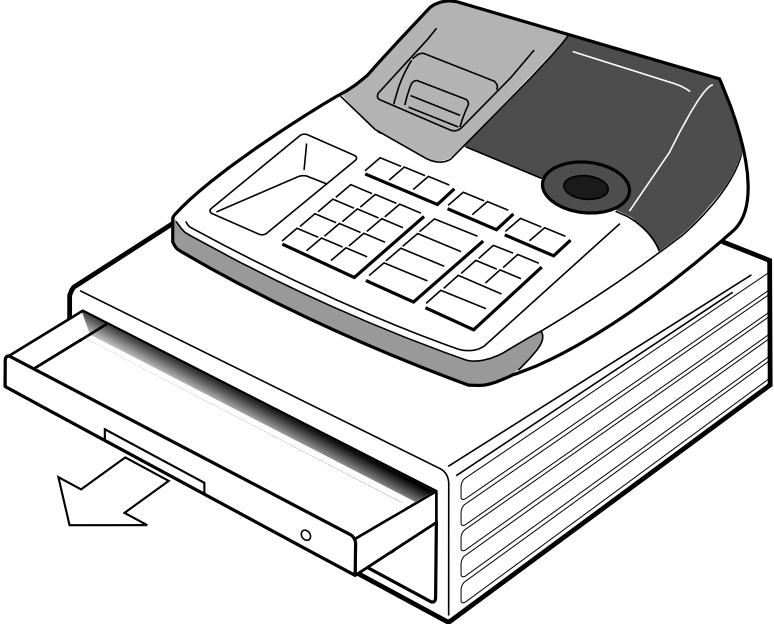

To lock/unlock the multipurpose tray

- A. Turn the lever (1) clockwise to lock the tray (the indicator becomes red).
- B. Turn the lever (1) counterclockwise to unlock the tray (the indicator becomes green).

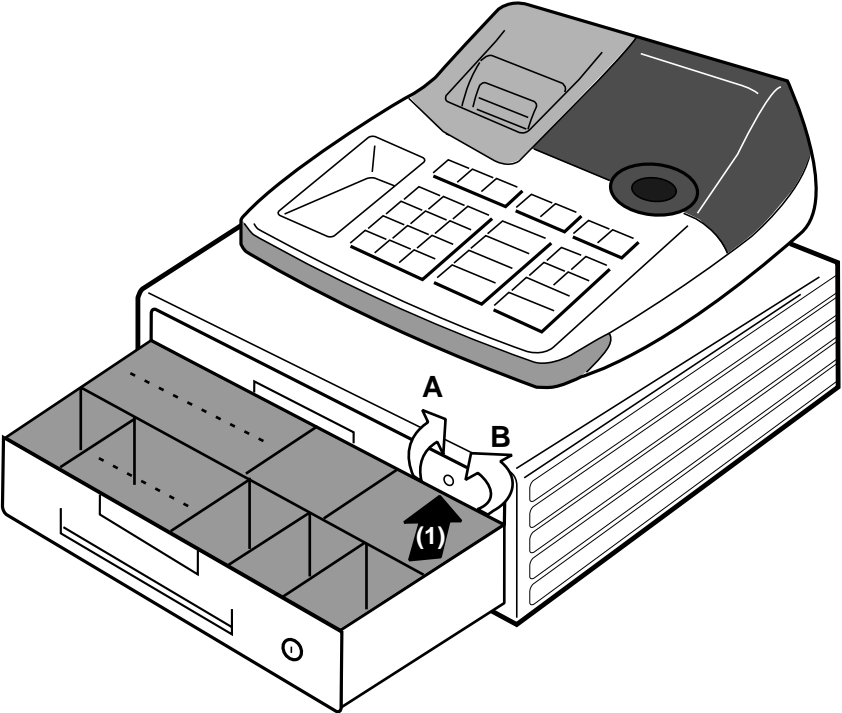

CASIO®

CASIO COMPUTER CO., LTD.
6-2, Hon-machi 1-chome
Shibuya-ku, Tokyo 151-8543, Japan

IR0111-A

120CR-B/160CR-B*E

Printed in Malaysia