

ELECTRONIC CASH REGISTER



Programming & Operation Manual

All specifications are subject to change without notice.

UNPACKING AND START UP INSTRUCTIONS

The following instructions describe how to unpack and start up the cash register.

STEP 1 UNPACK CASH REGISTER.

1. Unpack and unwrap the cash register.
2. Locate in the packing the following items.
 - * 2 rolls of paper
 - * 1 rewind spindle
 - * 1 ribbon cartridge
3. Remove cardboard protectors from the cash drawer.

STEP 2 INSERTING THE PRINTER RIBBON CARTRIDGE

1. Locate the printer cover key. The printer cover key is the smallest on the key ring. Insert this key into the printer cover lock. Turn the key, and remove the printer cover.
2. Locate the ribbon cartridge as shown in the illustration.
3. Insert the ribbon cartridge and press firmly into place. Remove any slack in the ribbon by rotating the cartridge knob counter-clockwise.

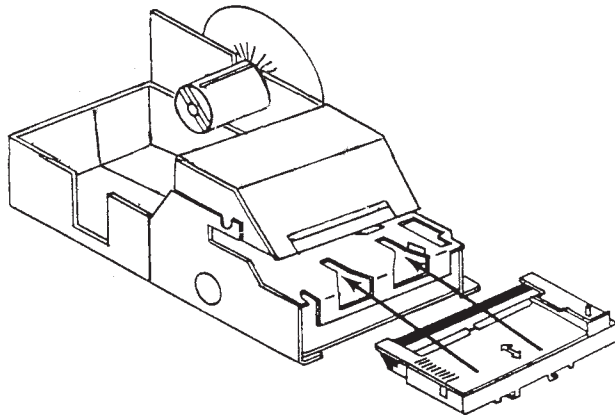

STEP 3 PUTTING PAPER IN THE PRINTER.

INITIAL LOADING OF THE DETAIL PRINTER:

1. Plug the cash register's power code into properly grounded wall socket.
2. Place the key marked 'REG' into the control lock and turn to the 'REG' position.
3. Locate the black plastic rewind spindle in the styrofoam packing material.
4. As you face the keyboard, notice two plastic trays at the bottom of the printer compartment. Place one of the rolls of printer paper into the tray on the right. Make sure the paper will unwind from the bottom of the roll.
5. Fold back approximately 6 inches of paper and insert the folded end of the tape into the feed slot just in front of the paper tray at the rear of the printer.
6. Press the DETAIL FEED key on the cash register keyboard until the edge has fed through the printer. Run 6 - 8 inches of paper through the printer.
7. Hold the black rewind spindle with the gear to the right and the shaft to the left. Insert the end of the paper into the slot on the shaft of the rewind spindle. Wind the spindle several turns to be sure the paper will stay on the spindle.
8. Slide the axle of the rewind spindle (between the gear and the shaft) into the notch of the printer housing. Make sure the gear on the rewind spindle meshes with the gear on the printer.
9. Press the DETAIL FEED key several more times to make sure the paper moves properly through the printer.

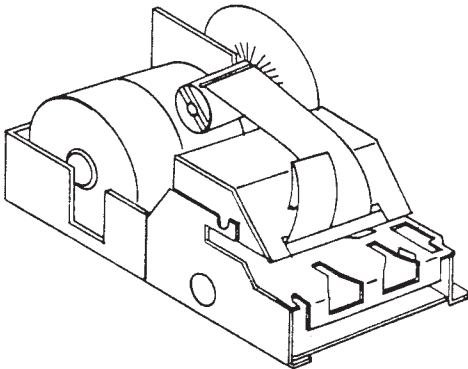

* LOADING DETAIL PAPER *

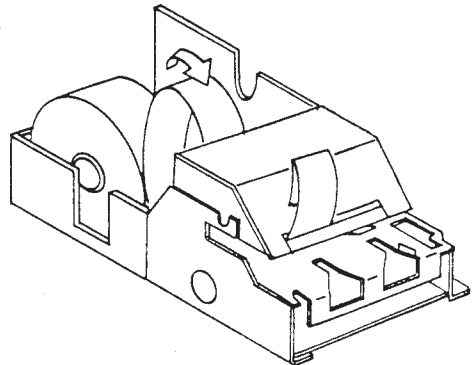

* LOADING RECEIPT PAPER *

LOADING THE RECEIPT PRINTER:

1. Place the other roll of paper into the small tray of the left of the printer compartment.
2. Make sure the paper unrolls from the bottom of the roll.
3. Insert the paper into the left slot of the printer.
4. Press the RECEIPT FEED key until the paper comes through the printer.
Continue to press the key until 3 - 4 inches of paper are through the printer.
5. Replace the printer cover, making sure the receipt paper comes out through the opening in the printer cover.

FOLLOW THE STEPS ABOVE ANYTIME YOU NEED TO REPLACE THE RECEIPT OR DETAIL TAPES. HOWEVER, WHEN REPLACING DETAIL TAPES, CUT THE OLD DETAIL TAPE AT THE REWIND SPINDLE. THEN USE THE PAPER FEED KEY TO FREE THE OLD PAPER FROM THE PRINTER. UNWIND THE OLD DETAIL TAPE FROM THE REWIND SPINDLE.

NOTE : DO NOT PULL THE PAPER BACK THROUGH THE PRINTER AS THIS MAY DAMAGE IT.

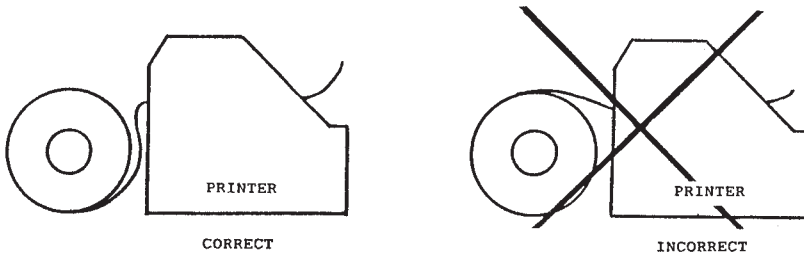

STEP 3 CLEARING THE RANDOM ACCESS MEMORY (RAM CLEARING)

Proper operation and programming of this ECR requires that you clear the RAM of the cash register. follow this procedure:

1. Unplug the cash register
2. Locate control lock key marked 'C'.
3. Insert the key into the control lock and turn clockwise, past the position marked 'P' to the 'SERVICE MODE' position. This position is not marked on the control lock, but the 'C' key can travel to this position.
4. Hold down the " 00 " key on the keyboard. While continuing to hold this " 00 " key down, plug the cash register's power cord into properly grounded wall socket.

CONTINUE TO HOLD THE " 00 " KEY DOWN UNTIL THE RECEIPT PRINTER STOPS PRINTING AND THE DISPLAY SHOWS 0.00.

The cash register is now ready to operate.

WARNING : Clearing the RAM is essential before you program the cash register for the first time. However once the register is programmed and operated, clearing the RAM will cause all programs and totals to be lost.

* WARNING : - The printer cover should not be open while operating the machine.

- Do not operate the machine without a ribbon cartridge.

* The power cord serves as a disconnect device.

NOTE : When first configuring the ECR, it is recommended that the register remain powered on in the "REG" mode for at least twenty-four hours. This allows the Ni-Cad battery, which maintains the memory of the machine while the power is off, to charge completely

TABLE OF CONTENTS

FEATURES	8
KEYBOARD LAYOUT	9
FUNCTION KEY DESCRIPTION	10
CONTROL LOCK	12
CONTROL KEYS	12
DISPLAY	13
DISPLAY SYMBOLS	13
PROGRAMMING NOTE	14
1. SERVICE MODE PROGRAMMING	14
2. SETTING THE NUMBER OF DEPARTMENTS	16
3. TRAINING MODE PROGRAMMING	16
4. PROGRAMMING	17
DATE AND TIME PROGRAMMING	17
REGISTER NUMBER PROGRAMMING	17
TAX PROGRAMMING	18
CLERK SECRET CODE PROGRAMMING	19
DESCRIPTOR PROGRAMMING	20
DEPARTMENT PROGRAMMING	24
PLU PROGRAMMING	28
% KEY PROGRAMMING	33
CASH/TEND KEY PROGRAMMING	34
CHECK KEY PROGRAMMING	35
CHARGE 1 & 2 KEY PROGRAMMING	35
PRESET CASH KEY PROGRAMMING	36
CASH IN DRAWER LIMIT PROGRAMMING	36
CURRENCY CONVERSION KEY PROGRAMMING	36
SYSTEM OPTION PROGRAMMING	37
PARAMETERS PROGRAM SCAN	41

INSTRUCTION TO THE OPERATIONS MANUAL	42
CLERK SIGN ON	42
CLEARING AN ERROR CONDITION	43
NO SALE OPERATION	43
NON-ADD NUMBER ENTRIES	43
DEPARTMENT ENTRIES	43
A. OPEN DEPARTMENT ENTRIES	43
B. PRESET DEPARTMENT ENTRIES	45
C. GALLONAGE DEPARTMENT OPERATION	46
PLU (PRICE LOOK UP) ENTRIES	46
A. OPEN PLU ENTRIES	46
B. PRESET PLU ENTRIES	48
C. PLU TO PLU CHAIN OPERATION	49
SINGLE ITEM DEPARTMENT OR PLU ENTRIES	49
COMPUTATION OF VAT	50
A. INCLUSIVE VAT	50
B. EXCLUSIVE VAT	51
% KEY ENTRIES	52
A. DISCOUNT/SURCHARGE OPERATION	52
B. COUPON/PRESET AMOUNT DISCOUNT OPERATION	53
C. COUPON 2 OPERATION.....	54
MERCHANDISE RETURN OPERATION	55
VOID OPERATION	56
A. VOID OF A LAST ITEM ENTRY	56
B. VOID OF A PREVIOUS ITEM ENTRY	56
C. VOID OUTSIDE OF A SALE	57
D. CANCEL OPERATION	57
ADD CHECK OPERATION	58
TENDERING OPERATION	58
A. CASH TENDER	58

B. PRESET CASH TENDER	59
C. CHECK TENDER	59
D. CHARGE TENDER	60
E. SPLIT TENDER	60
F. TENDERING WITH CURRENCY CONVERSION	61
G. POST TENDERING	61
CHECK CASHING	62
RECEIVED ON ACCOUNT OPERATIONS	62
PAID OUT OPERATIONS	63
PRINTING A BUFFERED RECEIPT OPERATIONS	63
VALIDATION OPERATIONS	64
RECEIPT FRONT MESSAGE PRINTING OPERATIONS	65
TRAINING OPERATIONS	66
REPORT AND BALANCING	67
REPORT MODE	68
CASH DECLARATION OPERATION	68
1. FINANCIAL REPORT	69
2. TIME REPORT	72
3. PLU REPORT	73
4. FROM/TO PLU REPORT	73
5. CASH IN DRAWER REPORT	74
6. CHECK IN DRAWER REPORT	74
7. DAILY REPORT	74
8. INDIVIDUAL CLERK REPORT	75
9. FROM/TO DEPARTMENT REPORT	77
10. DEPARTMENT GROUP REPORT	77
GLOSSARY	78
TROUBLE SHOOTING	79
MEMORY PROTECTION BATTERY	79
SPECIFICATION	80

FEATURES

This Electronic Cash Register is designed for general retail applications requiring efficient management control and simplicity of operation.

High precision electronic parts ensure outstanding reliability.

- * Two-station printer with one-line validation capabilities.
- * Front and rear/pop up displays.
- * 6-positions control lock.
- * 24 hour time clock with automatic date change.
- * 15 departments (ER-4615)
40 departments (ER-4640)
- * 300 open or preset PLUs.
- * 4 push-button clerks with separate report totals.
- * 4 VAT or straight percentage TAX.
- * Management reports.
 - Daily and period-to-date financial, hourly, plu and clerk reports.
 - Daily sales report.
 - Optional compulsory cash declaration.
- * Cancel function.
- * Currency conversion function
- * Post tendering.
- * Preset cash tendering.
- * Add check function.
- * Training operation.
- * Cash drawer compulsory.

KEYBOARD LAYOUT

The diagram below indicate the keyboard on this ECR.

1. ER - 4615 keyboard layout.

RECEIPT ON/OFF	RECEIPT FEED	DETAIL FEED	P L U	RECD ACCT	PAID OUT	A	B	D	E
VALID	VOID	CLEAR	#/NS	X/TIME	5	10	15	ADD CHECK	PRESET CASH
MDSE RETURN	VAT	7	8	9	4	9	14	CHARGE 1	PRESET CASH
CANCEL	VAT SHIFT	4	5	6	3	8	13	CHARGE 2	PRESET CASH
* 1	CONV 1	1	2	3	2	7	12	CHECK	SUBTOTAL
* 2	CONV 2	0	00	.	1	6	11	CASH/TEND	

2. ER - 4640 keyboard layout.

RECEIPT ON/OFF	RECEIPT FEED	DETAIL FEED	VALID	#/NS	VAT	VAT SHIFT	P L U		RECD ACCT	PAID OUT	A	B	D	E
VOID	ADD CHECK	C L E A R		X/TIME	5	10	15	20	25	30	35	40	CHARGE 1	PRESET CASH
MDSE RETURN	CONV 1	7	8	9	4	9	14	19	24	29	34	39	CHARGE 2	PRESET CASH
CANCEL	CONV 2	4	5	6	3	8	13	18	23	28	33	38	CHECK	PRESET CASH
* 1	* 3	1	2	3	2	7	12	17	22	27	32	37	SUBTOTAL	
* 2	* 4	0	00	.	1	6	11	16	21	26	31	36	CASH/TEND	

FUNCTION KEY DESCRIPTION

<u>KEY</u>	<u>DESCRIPTION</u>
RECEIPT ON/OFF	Use this key to turn the receipt print on and off. When the RECEIPT OFF sign is illuminated on the display panel, the receipt printer will be turned off.
RECEIPT FEED	Press this key to advance the customer's receipt tape.
DETAIL FEED	Press this key to advance the detail tape.
A, B, D, E (CLERK)	Use these four keys to log on clerks for operations and reports. A clerk must be logged on before the cash register will operate.
VALID (VALIDATION)	Use this key to print one line validation on a check or slip.
MDSE RETURN (MERCHANDISE RETURN)	Use this key to return merchandise outside of sale. MDSE RETURN activity reports to a total on the financial report.
#/NS	Use this key to open the cash drawer outside of a sale. This key can also be used to enter numbers that appear on the receipt and detail tapes but do not affect the sale total.
VAT (VALUE ADDED TAX)	Use this key to breakdown the amount due including value added tax.
VAT SHIFT	Use this key to shift the tax status of a particular department or PLU.
PLU	Use this key to register a Price Look Up (PLU)
VOID	Use the void key to correct entries before a sale is finalized.
CANCEL	Use this key to cancel present incomplete transactions without updating departments, PLU's, or function key totals. Cancel total is accumulated for the cancel function key itself in the financial report. The number of items to be canceled are limited to about 30 items before the tendering operation.
CLEAR	Use this key to clear incorrect entries made on the 10 numeric keys. The clear key also clears error conditions and silence's the error tone.
X/TIME	Use this key for multiplication and split pricing.
DEPARTMENTS (ER-4615 : 1 - 15) (ER-4640 : 1 - 40)	Use these keys to make entries during a sale
GALLONAGE DEPARTMENT KEYS	Open-amount department entry keys which compute quantity sold by dividing amount entered by the programmed unit price when department keys are programmed with gallonage department status.
% 1 , % 2	Use these key to register discount, surcharge and coupons. Depending on programming, the %1 - %4 keys can be used to register per-
% 3 , % 4	cents or amount, can be added to an item or an entire sale. (% 3 and % 4 - For only ER-4640)

<u>K E Y</u>	<u>DESCRIPTION</u>
1 - 9, 0, 00	Use these numeric keys for all numeric entries on the cash register.
DECIMAL (.)	Use this key for decimal multiplication.(= DECIMAL POINT)
RECD ACCT (R/A)	Use this key to register cash and check(media) added to the cash till.(= RECEIVED ACCOUNT)
PAID OUT (P/O)	Use this key to register media that is removed from the cash drawer.
CURRENCY CONVERSION (CONV 1, CONV 2)	Use this key to convert a home currency to the equivalent of another country's currency. These keys are allowed after subtotal, convert and re-display the subtotal at a preprogrammed exchange rate. Tendering is allowed after using the currency conversion function. Change is calculated in home currency. The amount of foreign currency tendered is stored in a separate total on the financial report, but not added to the drawer total.
ADD CHECK	Use this key to combine individual guest checks that will be tendered together. Each add check entry will advance the consecutive number.
CHECK	Use this key to finalize a sale that is paid by check.
CHARGE 1 CHARGE 2	Use these keys to finalize a sale paid with a charge account. Over tender is not allowed when you finalize with the " CHARGE " key.
PRESET CASH	Use this key to finalize sales paid with cash. These keys are preset amount cash tender keys which have programmable values. By depressing a preset tender key at the end of a transaction, the preset amount is automatically tendered and the sale is finalized as a cash transaction.
SUBTOTAL	Use this key to display a subtotal.
CASH/TEND	Use this key to finalize sales paid with cash. Enter the amount tendered before pressing the " CASH/TEND " key for change calculations.

CONTROL LOCK

This ECR has a 6 position control lock.

<u>POSITION</u>	<u>USE</u>
VOID	Used to void operations outside of a sale.
OFF	Register will not operate in the off position.
REG	Used for all normal operations.
X	Used to print X level reports. Also used for manager control of voids and merchandise returns.
Z	Used to print Z level reports. Reset totals to zero.
P	Used to program the ECR.

CONTROL KEYS

This ECR has five control keys.
Each key has a specific range in the control lock, See the following.

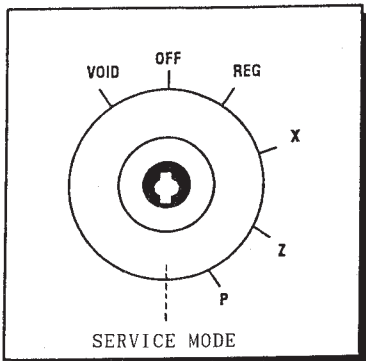

- * REG - travel from 'OFF' to 'REG'
- * VD - travel from 'VOID' to 'X'
- * Z - travel from 'VOID' to 'Z'
- * P - travel from 'VOID' to 'P'
- * C - travel to all key positions.





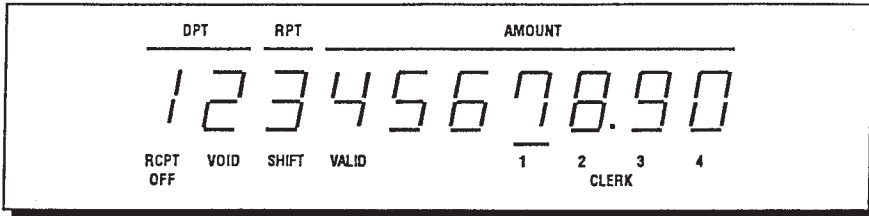





DISPLAY

This ECR has a front or operator display and pop up display. The front display has indicator lights. These lights provide only the operator with information about the operation of ECR.



DISPLAY SYMBOLS

During operation, the display will show the following symbols:

	<p>Indicates the amount displayed is due as change.</p>
	<p>Indicates the amount displayed is a total</p>
	<p>Indicates the amount displayed is negative. This symbol shows directly in front of negative amount.</p>
	<p>Indicates that the amount displayed is a subtotal.</p>
	<p>Indicates an error condition. Press the " CLEAR " key to clear this condition.</p>
	<p>Indicates cash drawer must be closed.</p>
	<p>Indicates that validation is required.</p>
	<p>Indicates RECD ACCT or PAID OUT transaction is not finalized.</p>
	<p>Indicates ADD CHECK transaction is not finalized.</p>
	<p>Indicates paper jam - please turn the power off and remove the paper in the printer, turn the power on again.</p>

PROGRAMMING NOTE

Programming this ECR is easy.

In this manual, the programming steps are explained with flow chart boxes. Each box represents a key on the keyboard.

The flow charts show each key stroke you need to complete the programming.

Enter the keys in flow chart from left to right.

Default program : This machine arrives with a default or "generic" program already installed. Program options are set to 0(Zero), unless otherwise noted, which means the machine is operational right out-of-the-box.

1. SERVICE MODE PROGRAMMING

Service mode programming is the initial programming that is required when the register is new "out of the box".

Service mode programming is also used to return the register to this condition. A total memory RAM clear will clear all totals and counters, will reset all programming options to '0', returning the register to its default, or "out of box" program.

In addition, the number of active departments is fixed as part of the service mode programming. Also training is programmed in the service mode position.

1) RAM CLEARING

This ECR has two RAM clearing steps.

A. INITIAL CLEAR

Keyboard lock-ups and constant error conditions may be cleared by the following procedure.

- (1) Turn the keylock to the 'P' position and depress the " SUBTOTAL " key.
- (2) While holding the " SUBTOTAL " key down, power the register off, and back on.

CONTINUE TO HOLD THE " SUBTOTAL " KEY DOWN UNTIL THE RECEIPT PRINTER STOPS PRINTING AND THE DISPLAY SHOW 0.00.

This procedure will not effect register programming, or clear previously stored totals in RAM memory.

The receipt will look like this :

```
*****  
INITIAL CLEAR OK !  
*****
```

* INITIAL CLEAR *

B. CLEARING TOTALS FROM MEMORY

Totals and counters may be reset to zero either all at once, or a section at a time. Using the following list as a guide, choose the procedure for clearing the desired section of memory.

* ALL MEMORY RAM CLEAR

RAM clearing the cash register erases all programming and totals. Use this program the first time the cash register is programmed.

* RESET ALL TOTALS & COUNTERS

This procedure will reset ALL total and counters. (Consecutive NO, Z-counter, Grand total) This procedure will not effect register programming.

* RESET GRAND TOTAL ONLY

This procedure resets the Grand total only, leaving all other programming, totals and counters intact.

Follow this procedure to clear totals from memory

- (1) Unplug ECR.
- (2) Insert lock key marked 'C' into the control lock and turn clockwise, past the position marked 'P', to the 'SERVICE MODE'(Master clear position) position. This position is not marked on the control lock, but the 'C' key will travel to this position.
- (3) Choose the desired operation from those listed below. While holding the SPECIFIED key down, plug-in the ECR.

CONTINUE TO HOLD THE KEY DOWN UNTIL THE RECEIPT PRINTER STOPS PRINTING AND THE DISPLAY SHOW 0.00.

KEYS

- 0 0 = ALL MEMORY RAM CLEAR
- CHECK = RESET ALL TOTALS & COUNTERS
- CASH/TEND = RESET GRAND TOTAL ONLY

```

*****
RAM ALL CLEAR OK !
*****

```

* ALL MEMORY RAM CLEAR *

```

*****
RESET ALL CNT/TOTAL !
*****

```

```

*****
RESET GRAND TOTAL !
*****

```

* RESET ALL TOTALS & COUNTERS *

* RESET GRAND TOTAL ONLY *

4. PROGRAMMING

THE BALANCE OF ALL PROGRAMMING PROCEDURES TAKES PLACE WITH THE CONTROL LOCK IN THE 'P' POSITION.

* DATE AND TIME PROGRAMMING *

1. To program the date :

A. Enter the date in the form of MM DD YY or DD MM YY or YY MM DD and week.
 (The order of date is set by SYSTEM OPTION ADDRESS 7 : Page 37)

B. Press the " X/TIME " key.

2. To program the time :

A. Enter standard military time in the form of HH MM.

B. Press the " X/TIME " key.

EX) 25 DECEMBER 1993, SUNDAY

12:00 noon

(1 2 2 5 9 3 0) — X/TIME

(1 2 0 0) — X/TIME

WEEK TABLE

WEEK VALUE :			
SUNDAY	0	WEDNESDAY	3
MONDAY	1	THURSDAY	4
TUESDAY	2	FRIDAY	5
		SATURDAY	6

In military time noon = 1200
 midnight = 0000
 1:30 pm = 1330
 and so on

The receipt tape will look like this :

DATE 12.25.'93	SUN
TIME 12:00	

* REGISTER NUMBER PROGRAMMING *

1. Enter register number up to 4 digits.

2. Press the " MDSE RETURN " key.

D1	D2	D3	D4	MDSE RETURN
----	----	----	----	-------------

Sample receipt of register number printing :

MACHINE NO.	9999
-------------	------

*** TAX PROGRAMMING ***

You can program four tax rates on this ECR.

This ECR can calculate tax by two methods:

* Value Added Taxes (VAT) : INCLUSIVE VAT

* Straight percentage taxes : EXCLUSIVE VAT

IMPORTANT : TO PROGRAM TAX AS INCLUSIVE, MAKE SURE SYSTEM OPTION ADDRESS 31 SET TO 0.
TO PROGRAM TAX AS EXCLUSIVE, MAKE SURE SYSTEM OPTION ADDRESS 31 SET TO 1.

NOTE : IF YOU HAVE RAM CLEARED, THE MACHINE HAS THE INCLUSIVE TAX SYSTEM.

*** VAT RATE PROGRAMMING**

1. Depress numeric NO. (1,2,3 or 4) and depress the " VAT " key.

2. From the numeric key pad enter the percentage of tax.
You must use the decimal(.) key.

EX) 10 % tax by entering : 1 0 . 0 0 0
6.25 % tax by entering : 6 . 2 5 0

NOTE : YOU MUST ENTER 3 NUMBERS AFTER THE DECIMAL POINT.

3. Depress " SUBTOTAL " key.

If you want to use the tax rounding system, refer to SYSTEM OPTION ADDRESS 29 (Page 40).

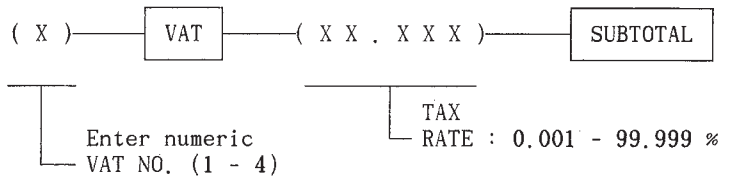

Sample receipt of VAT rate :

VAT 1 ———	TAX1 RATE	10.000%
VAT 2 ———	TAX2 RATE	8.000%
VAT 3 ———	TAX3 RATE	6.000%
VAT 4 ———	TAX4 RATE	5.000%

*** CLERK SECRET CODE AND DRAWER ASSIGNMENT PROGRAMMING ***

A. CLERK SECRET CODE PROGRAMMING

When you want to use the clerk code system, you should set the SYSTEM OPTION ADDRESS 26 (Page 39).

This program assigns a clerk code number to each of the 4 clerks. The code number is used by the clerk to log on for operations.

1. To program the clerk code, press the "CLERK (A,B,D or E)" key to be programmed.

NOTE : The CLERK key to be programmed must be logged off.

2. Press the clerk number (1-4) and press the "DECIMAL POINT(.)" key.
3. Enter a secret clerk code number up to 6 digits long. And depress the "CASH/TEND" key to finalize clerk secret code programming. Repeat for up to 4 clerks.

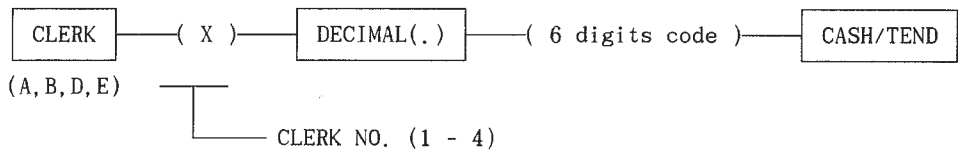

Sample receipt of clerk code input:

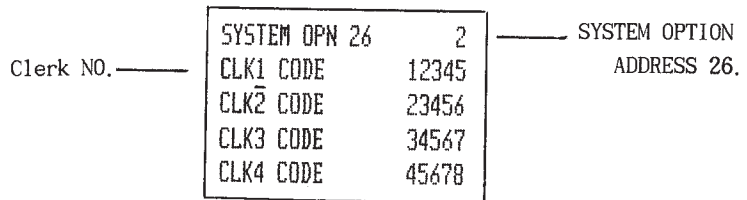

B. CLERK DRAWER ASSIGNMENT

1. Press the "CLERK (A,B,D or E)" key to be programmed.

NOTE : the CLERK key to be programmed must be logged off.

2. Press drawer number '1' or '2' and press "#/NS" key.
3. Depress the "CASH/TEND" key to finalize drawer assignment.

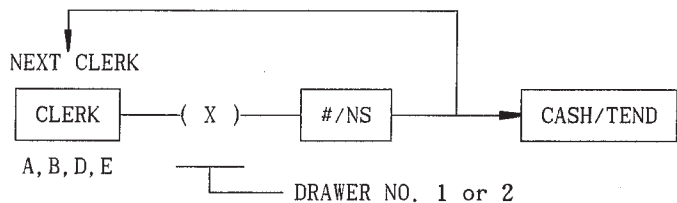

NOTE : Default drawer assignment for all clerks is drawer 1.

*** DESCRIPTOR PROGRAMMING ***

You can program descriptors for each department key, plu keys, clerk names, department group and some function keys using the following programming procedure.

A. PROGRAMMING

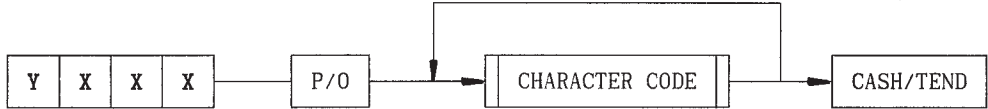

* Refer to character code table (page 23)

STANDARD DESCRIPTOR	ADDRESS	NUMBER	CHARACTER	REMARKS
	Y	X X X	LENGTH	
DEPARMENT	1	001 - 015	12 CHAR.	- ER-4615
		001 - 040	12 CHAR.	- ER-4640
PLU	2	001 - 300	12 CHAR.	
CLERK1	3	0 0 1	12 CHAR.	
CLERK2	3	0 0 2	12 CHAR.	
CLERK3	3	0 0 3	12 CHAR.	
CLERK4	3	0 0 4	12 CHAR.	
GROUP0	3	0 0 5	12 CHAR.	
GROUP1	3	0 0 6	12 CHAR.	
GROUP2	3	0 0 7	12 CHAR.	
GROUP3	3	0 0 8	12 CHAR.	
GROUP4	3	0 0 9	12 CHAR.	
GROUP5	3	0 1 0	12 CHAR.	
GROUP6	3	0 1 1	12 CHAR.	
GROUP7	3	0 1 2	12 CHAR.	
GROUP8	3	0 1 3	12 CHAR.	
GROUP9	3	0 1 4	12 CHAR.	
CASH	3	0 1 5	12 CHAR.	
CHECK	3	0 1 6	12 CHAR.	
CHG1	3	0 1 7	12 CHAR.	
CHG2	3	0 1 8	12 CHAR.	
CHANGE	3	0 1 9	12 CHAR.	
TOTAL	3	0 2 0	12 CHAR.	
R/A	3	0 2 1	12 CHAR.	
P/O	3	0 2 2	12 CHAR.	
RCPT MESGE 1	4	0 0 1	21 CHAR.	- RECEIPT
RCPT MESGE 2	4	0 0 2	21 CHAR.	FRONT
RCPT MESGE 3	4	0 0 3	21 CHAR.	MESSAGE

B. DESCRIPTOR PROGRAMMING EXAMPLES

1. DEPT.1 = APPLE

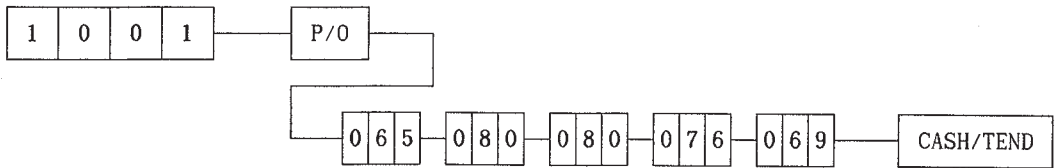

2. PLU 10 = ORANGE

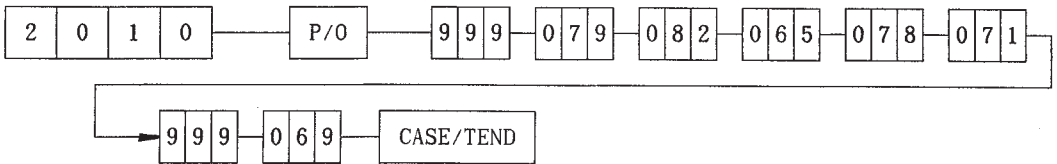

3. CLERK4 = MR. JOHN

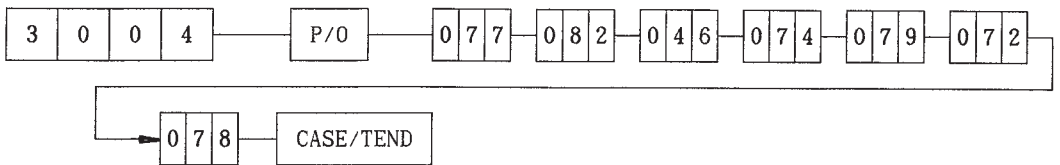

4. RECEIPT FRONT MESSAGE LINE 1 = Thank You

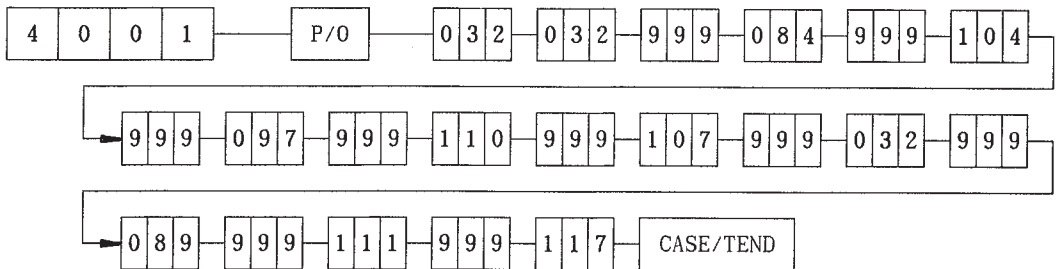

C. DESCRIPTOR PROGRAMMING SCAN



```

DATE 12.25.'93  SUN
-----
DESCRIPTOR SCAN
-----
DEPT.1: APPLE
-----
PLU 10: ORANGE
-----
CLERK1 :
CLERK2 :
CLERK3 :
CLERK4 : MR.JOHN
GROUP0 :
GROUP1 :
GROUP2 :
GROUP3 :
GROUP4 :
GROUP5 :
GROUP6 :
GROUP7 :
GROUP8 :
GROUP9 :
CASH :
CHECK :
CHG1 :
CHG2 :
CHANGE :
TOTAL :
R/A :
P/O :
-----
Thank You
ER-4615/40
Dot Matrix Printer
-----
CLERK 0 NO.000009
TIME 12:19 9999
  
```

- Dept. descriptor
- PLU descriptor
- Clerk descriptor
- Dept. group descriptor
- Function key descriptor
- Receipt front message descriptor
- Receipt consecutive NO.
- Register NO.

*** CHARACTER CODE TABLE ***

CHAR	á	à	â	ä	å	Ä	Å	é	è	ê
CODE	001	002	003	004	005	006	007	008	009	010
CHAR	ë	É	Í	ï	î	ï	í	ñ	Ñ	ó
CODE	011	012	013	014	015	016	017	018	019	020
CHAR	ò	ô	ö	Ö	Ú	Û	ü	û	Ü	æ
CODE	021	022	023	024	025	026	027	028	029	030
CHAR	ß	SPACE	!	~	#	\$	%	&	'	(
CODE	031	032	033	034	035	036	037	038	039	040
CHAR)	*	+	,	-	.	/	0	1	2
CODE	041	042	043	044	045	046	047	048	049	050
CHAR	3	4	5	6	7	8	9	:	;	<
CODE	051	052	053	054	055	056	057	058	059	060
CHAR	=	>	?	@	A	B	C	D	E	F
CODE	061	062	063	064	065	066	067	068	069	070
CHAR	G	H	I	J	K	L	M	N	O	P
CODE	071	072	073	074	075	076	077	078	079	080
CHAR	Q	R	S	T	U	V	W	X	Y	Z
CODE	081	082	083	084	085	086	087	088	089	090
CHAR	Æ	Ŕ	f	ç	£	Ft	a	b	c	d
CODE	091	092	093	094	095	096	097	098	099	100
CHAR	e	f	g	h	i	j	k	l	m	n
CODE	101	102	103	104	105	106	107	108	109	110
CHAR	o	p	q	r	s	t	u	v	w	x
CODE	111	112	113	114	115	116	117	118	119	120
CHAR	y	z								
CODE	121	122								

CHAR	DOUBLE WIDE
CODE	999

* Double wide character must be preceded "999", and count as two character.

* DEPARTMENT PROGRAMMING *

Department programming takes place in two steps. The first step programs the department status, the second step programs the preset price or HALO(HIGH AMOUNT LOCK OUT).

Sales registered into hash departments do not add to the grand total, gross sales total and may also be programmed not to add to the net sales total.

Hash departments add to the total of each sale and therefore are included in all medias and drawer totals. Like normal departments, hash departments also add into a total of all hash departments and PLUs on the financial report.

Typically hash departments may be used to register items such as delivery charges or lottery sales that a merchant may not want to appear in accumulated sales totals. SYSTEM OPTION ADDRESS 23 VALUE 'b' (Page 39) is used to select whether hash department totals add to the net sales totals.

A. DEPARTMENT STATUS PROGRAMMING

* PROGRAMMING OPTION

PROGRAMMING OPTION	VALUE		OPTION DIGIT
Department GROUP NO.	0 - 9		N 0
Resettable counter, counter will increase Nonresettable counter, counter will increase Resettable counter, counter will decrease Nonresettable counter, counter will decrease	0 1 2 3		N 1
HASH department feature	a	YES = 1 NO = 0	N 2 = a + b + c
GALLONAGE department feature	b	YES = 2 NO = 0	
NON-ADD NUMBER compulsory	c	YES = 4 NO = 0	
Department is NEGATIVE	a	YES = 1 NO = 0	N 3 = a + b + c
Department is SINGLE ITEM	b	YES = 2 NO = 0	
VALIDATION compulsory	c	YES = 4 NO = 0	
Department is OPEN(HALO) DEPARTMENT Department is PRESET DEPARTMENT Department is DISABLED	0 1 2		N 4
Department is not taxable Department is taxable by VAT 1 Department is taxable by VAT 2 Department is taxable by VAT 3 Department is taxable by VAT 4 Department is taxable by VAT 1 & 3	0 1 2 3 4 5		N 5

* PROGRAMMING

1. Enter the option value of each department and press the " SUBTOTAL " key.
2. Depress each department key to be assigned that status.
3. Depress the " CASH/TEND " key to complete department status programming.

If the status is to be assigned to one department only, simply depress that department key, followed by the " CASH/TEND " key to complete status programming.

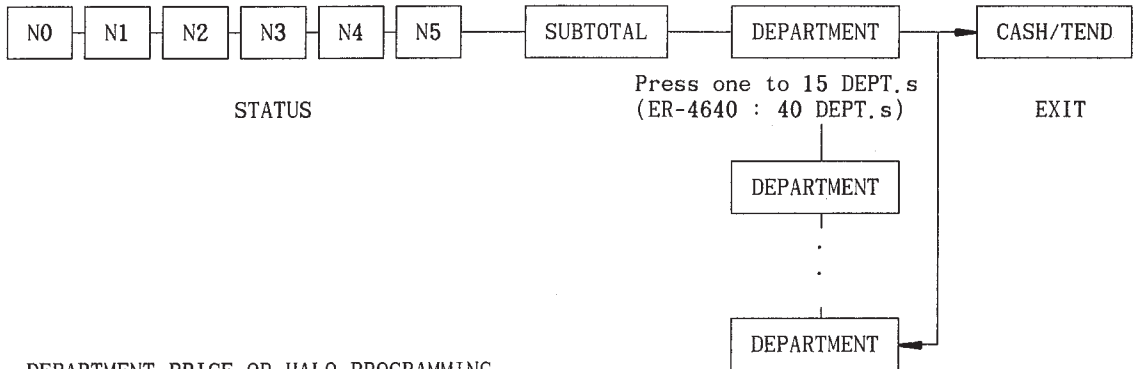

B. DEPARTMENT PRICE OR HALO PROGRAMMING

To establish a preset price or High Amount Lock Out (HALO), enter the amount and depress the appropriate department key.

A zero amount entry for open departments will set the HALO at the maximum seven digits (99999.99) for standard departments, and five digits (99.999) for gallonage departments.

Zero preset departments are allowed.

1. Enter the amount and depress the department to be programmed.
2. If you want to enter the activity counter, enter the activity counter (0 - 9999), and depress the " R/A " key.

NOTE : If you do not wish to make the activity counter, You can skip the STEP 2.

3. Depress the " CASH/TEND " key to complete department price or HALO programming.

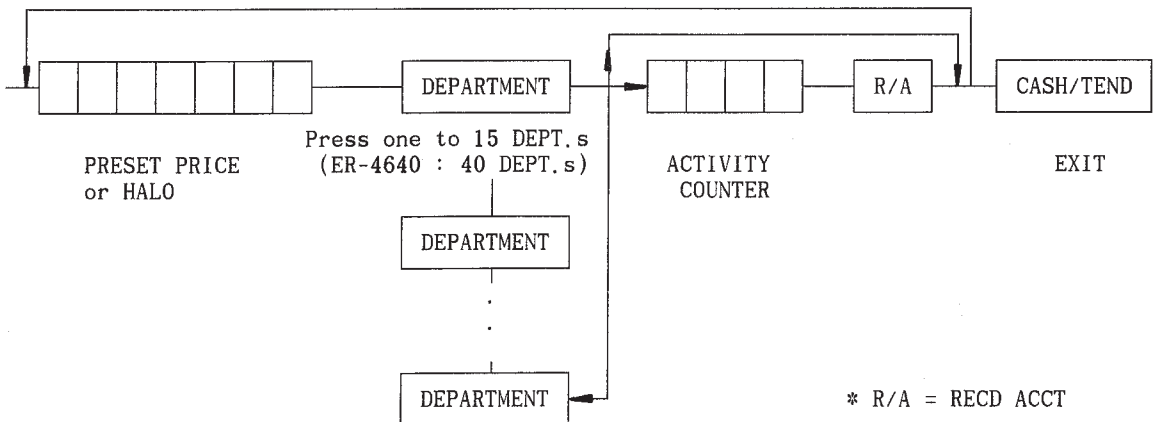

* R/A = RECD ACCT

C. DEPARTMENT PROGRAMMING EXAMPLES

1) DEPARTMENT STATUS PROGRAMMING

- EX1) Program 'DEPT 1' and 'DEPT 2'. 'DEPT 1' is VAT 1 and also 'DEPT 2' is VAT 1.
1. Enter numeric ' 1 ' and press the 'SUBTOTAL' key.
 2. Depress the 'DEPT 1' key and 'DEPT 2' key.
 3. Depress the 'CASH/TEND' key.
- EX2) Program 'DEPT 3' so it is a PRESET department and is VAT 2.
1. Enter numeric ' 1 2 ' and press the 'SUBTOTAL' key.
 2. Depress the 'DEPT 3' key and press the 'CASH/TEND' key.
- EX3) Program 'DEPT 4' so it is a PRESET and SINGLE ITEM department and VAT 3.
1. Enter numeric ' 2 1 3 ' and press the 'SUBTOTAL' key.
 2. Depress the 'DEPT 4' key and press the 'CASH/TEND' key.
- EX4) Program 'DEPT 5' so it is a NEGATIVE PRESET and NON TAX with and nonresettable counter increment status.
1. Enter numeric ' 1 0 1 1 0 ' and press the 'SUBTOTAL' key.
 2. Depress the 'DEPT 5' key and press the 'CASH/TEND' key.
- EX5) Program 'DEPT 6' so it is PRESET AND VAT 1 and VAT 3.
1. Enter numeric ' 1 5 ' and press the 'SUBTOTAL' key.
 2. Depress the 'DEPT 6' key and press the 'CASH/TEND' key.
- EX6) Program 'DEPT 10' so it is a GALLONAGE department and NON TAX.
1. Enter numeric ' 2 0 0 0 ' and press the 'SUBTOTAL' key.
 2. Depress the 'DEPT 10' key and press the 'CASH/TEND' key.
- EX7) Program 'DEPT 15' so it is accumulated in department GROUP 7 and HASH feature, PRESET and VAT 4.
1. Enter numeric ' 7 0 1 0 1 4 ' and press the 'SUBTOTAL' key.
 2. Depress the 'DEPT 15' key and press the 'CASH/TEND' key.

2) DEPARTMENT PRICE OR HALO PROGRAMMING

- EX1) Program 'DEPT 1' and 'DEPT 2'. 'DEPT 1' has a *99.99 HALO and also 'DEPT 2' has a *99.99 HALO.
1. Enter numeric ' 9 9 9 9 ' and press the 'DEPT 1' key and 'DEPT 2' key.
 2. Depress the 'CASH/TEND' key
- EX2) Program 'DEPT 3', 'DEPT 6' and 'DEPT 15'. These departments have a price *10.00.
1. Enter numeric ' 1 0 0 0 ' and press the 'DEPT 3' key, 'DEPT 6' and 'DEPT 15' key
 2. Depress the 'CASH/TEND' key.
- EX3) Program 'DEPT 4' so it has a price *15.00.
1. Enter numeric ' 1 5 0 0 ' and press the 'DEPT 4' key.
 2. Depress the 'CASH/TEND' key
- EX4) Program 'DEPT 5' so it has a price *1.00 and activity count is 50. Counter increment status.
1. Enter numeric ' 1 0 0 ' and press the 'DEPT 5' key.
 2. Enter activity counter ' 5 0 ' and press the 'R/A' key. (R/A = RECD ACCT)
 3. Depress the 'CASH/TEND' key
- EX5) Program 'DEPT 10' so it has a price *1.399(Gallonage price).
1. Enter numeric ' 1 . 3 9 9 ' and press the 'DEPT 10' key.
 2. Depress the 'CASH/TEND' key

D. DEPARTMENT PROGRAMMING SCAN

1. Depress the " CASH/TEND " key.
2. Depress the first " DEPARTMENT " key you want scan.
3. Depress the last " DEPARTMENT " key you want scan.

If you only want one programming printing out, Depress "DEPARTMENT" key twice.

NOTE : THE LAST DEPARTMENT MUST BE GREATER THAN THE FIRST DEPARTMENT.

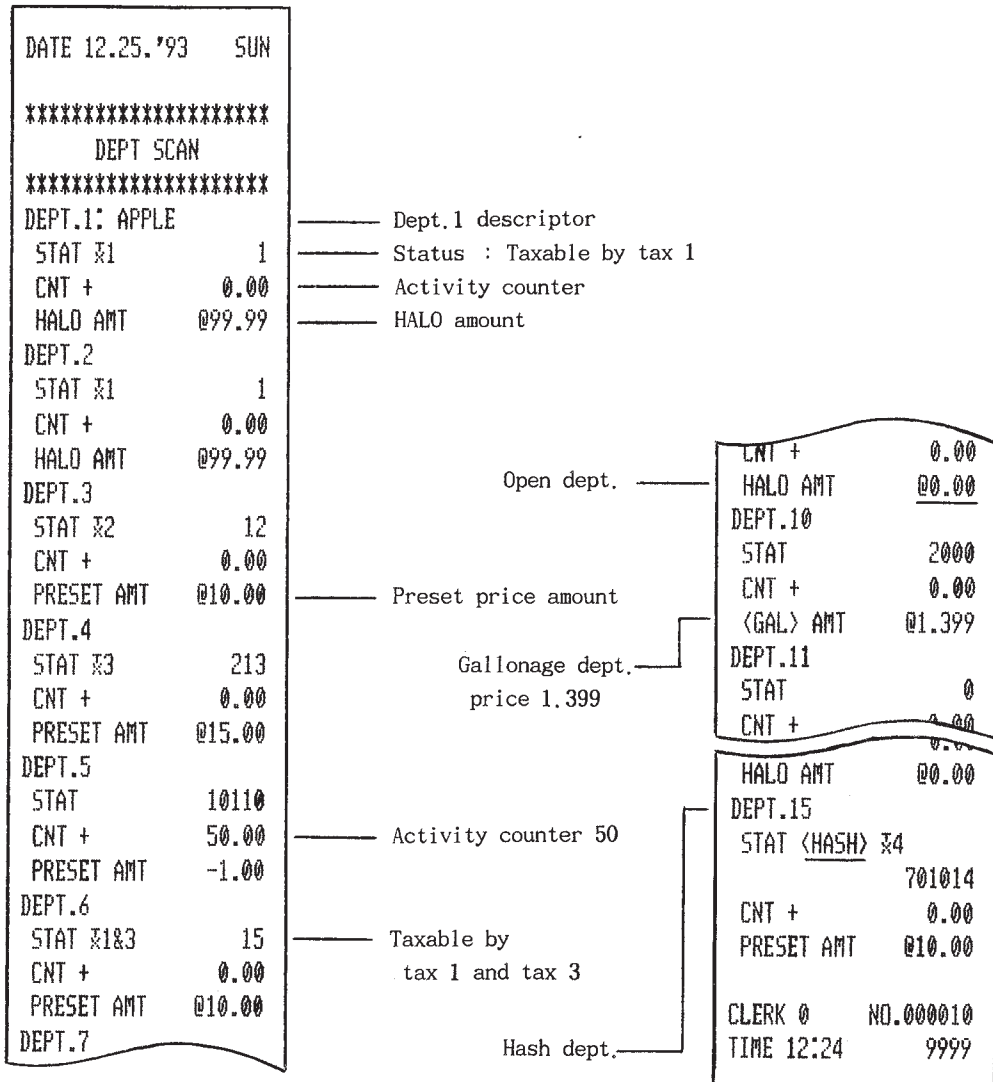

* PLU PROGRAMMING *

PLU status programming offers the same general feature as department programming.

Hash plu's operation is the same as hash department operation.
Refer to hash department notes.

A. PLU PROGRAMMING

* PROGRAMMING OPTION

PROGRAMMING OPTION	VALUE		OPTION DIGIT
Resetable counter, counter will increase Nonresetable counter, counter will increase Resetable counter, counter will decrease Nonresetable counter, counter will decrease	0 1 2 3		N 1
HASH PLU feature	a	YES = 1 NO = 0	N 2 = a + b + c
GALLONAGE PLU feature	b	YES = 2 NO = 0	
NON-ADD NUMBER compulsory	c	YES = 4 NO = 0	
PLU is NEGATIVE	a	YES = 1 NO = 0	N 3 = a + b + c
PLU is SINGLE ITEM	b	YES = 2 NO = 0	
VALIDATION compulsory	c	YES = 4 NO = 0	
PLU is OPEN(HALO) PLU PLU is PRESET PLU PLU is DISABLED	0 1 2		N 4
PLU is not taxable PLU is taxable by VAT 1 PLU is taxable by VAT 2 PLU is taxable by VAT 3 PLU is taxable by VAT 4 PLU is taxable by VAT 1 & 3	0 1 2 3 4 5		N 5

* PROGRAMMING

1. Enter A plu number (1 - 300) to be programmed , depress the " PLU " key.
Or
enter the number of the beginning plu of the range to be programmed, depress " PLU " key, and the number of the end plu in the range being programmed, depress " PLU " key.
2. Enter the status (up to 5 digits), and depress the linked department key, or enter the price (up to 7 digits), and press the " X/TIME " key.
3. If you want to enter the activity counter, enter the activity counter(0 - 9999), and depress the " R/A " key.

NOTE : If you do not wish to make the activity counter, You can skip the STEP 3.

4. Depress the " CASH/TEND " key to complete plu programming.

NOTE : In order to program a single PLU, enter one number only, (Skip the "TO" PLU entry). Followed by the PLU key, as the first step in the procedure.

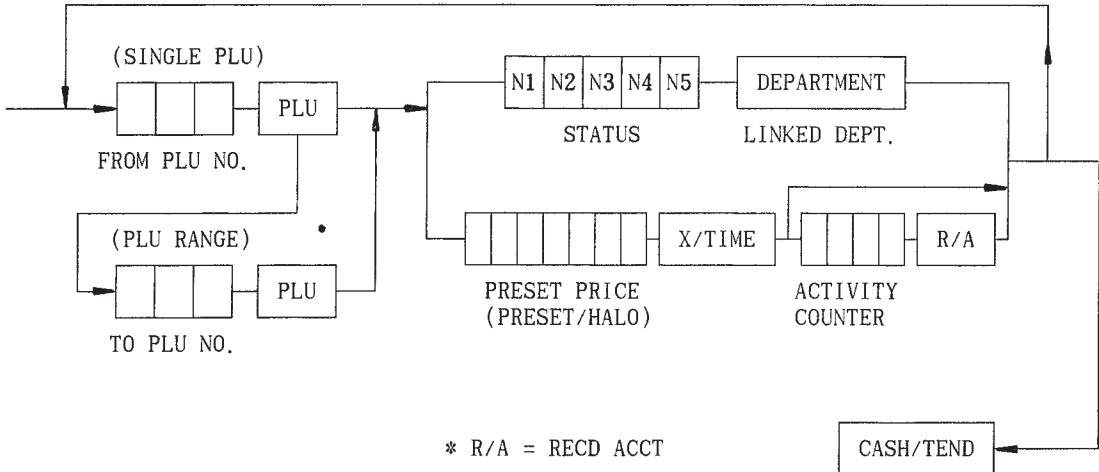

B. PLU PROGRAMMING EXAMPLES

IMPORTANT : IF PLU IS NOT LINKED TO DEPARTMENT, PLU REGISTRATION IS NOT ALLOWED.

- EX1) Program 'PLU 10' so it is VAT 1 and has a *99.99 HALO and linked to 'DEPT 1'.
1. Depress numeric ' 1 0 ' and 'PLU' key.
2. Enter numeric ' 1 ' and press 'DEPT 1' key for status.
3. Enter numeric ' 9 9 9 9 ' and press 'X/TIME' key for HALO amount.
4. Depress the 'CASH/TEND' key.
- EX2) Program 'PLU 20' so it is VAT 2 and has a PRESET price *10.00 and linked to 'DEPT 2'.
1. Depress numeric ' 2 0 ' and 'PLU' key.
2. Enter numeric ' 1 2 ' and press 'DEPT 2' key for status.
3. Enter numeric ' 1 0 0 0 ' and press 'X/TIME' key for PRESET amount.
4. Depress the 'CASH/TEND' key.
- EX3) Program 'PLU 30' so it is VAT 3, SINGLE ITEM and has a PRESET price *15.00 and linked to 'DEPT 3'.
1. Depress numeric ' 3 0 ' and 'PLU' key.
2. Enter numeric ' 2 1 3 ' and press 'DEPT 3' key for status.
3. Enter numeric ' 1 5 0 0 ' and press 'X/TIME' key for PRESET amount.
4. Depress the 'CASH/TEND' key.
- EX4) Program 'PLU 40' so it is VAT 4 and has a PRESET price *1.00 and linked to 'DEPT 4', initial activity counter is 100 with status nonresettable/decrement.
1. Depress numeric ' 4 0 ' and 'PLU' key.
2. Enter numeric ' 3 0 0 1 4 ' and press 'DEPT 4' key for status.
3. Enter numeric ' 1 0 0 ' and press 'X/TIME' key for PRESET amount, and enter numeric ' 1 0 0 ' and press 'R/A' key for activity counter.
4. Depress the 'CASH/TEND' key. (R/A = RECD ACCT)
- EX5) Program 'PLU 50' so it is VAT 1 and has a PRESET price *10.00 and linked to 'DEPT 6'.
1. Depress numeric ' 5 0 ' and 'PLU' key.
2. Enter numeric ' 1 1 ' and press 'DEPT 6' key for status.
3. Enter numeric ' 1 0 0 0 ' and press 'X/TIME' key for preset amount.
4. Depress the 'CASH/TEND' key.
- EX6) Program 'PLU 100' so it is VAT 1 and has a PRESET price *5.00 and linked to 'DEPT 6'.
1. Depress numeric ' 1 0 0 ' and 'PLU' key.
2. Enter numeric ' 1 1 ' and press 'DEPT 6' key for status.
3. Enter numeric ' 5 0 0 ' and press 'X/TIME' key for preset amount.
4. Depress the 'CASH/TEND' key.
- EX7) Link 'PLU 100' to 'PLU 50'.
(Refer to next page ' D. PLU LINK PROGRAMMING'.)
1. Enter numeric ' 5 0 ' and press 'PLU' key.
2. Enter numeric ' 1 0 0 ' and press '#/NS' key.
3. Depress the 'CASH/TEND' key.

C. PLU PROGRAMMING SCAN

1. Depress the " CASH/TEND " key.
2. Enter the number of the first PLU you want scan, and depress the " PLU " key.
3. Enter the number of the last PLU you want scan, and depress the " PLU " key.

NOTE : THE LAST PLU'S NUMBER MUST BE GREATER THAN THE FIRST PLU'S NUMBER.

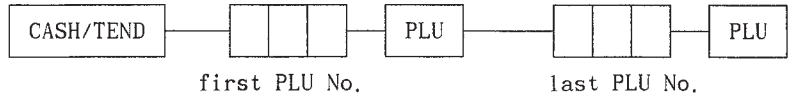

<pre> DATE 12.25.'93 SUN ***** PLU SCAN ***** PLU 10: ORANGE LINKED DEPT 1 STAT X1 1 CNT + 0.00 HALD AMT @99.99 PLU 20 LINKED DEPT 2 STAT X2 12 CNT + 0.00 PRESET AMT @10.00 PLU 30 LINKED DEPT 3 STAT X3 213 CNT + 0.00 PRESET AMT @15.00 PLU 40 LINKED DEPT 4 STAT X4 30014 CNT - 100.00 PRESET AMT @1.00 </pre>	<p>— PLU NO. & descriptor</p> <p>— Linked to dept. 1</p> <p>— Status</p> <p>— Activity counter</p>	<p>Link PLU NO. 100 —</p>
<pre> PLU 50 CHAIN PLU 100 LINKED DEPT 6 STAT X1 11 CNT + 0.00 PRESET AMT @10.00 PLU 100 LINKED DEPT 6 STAT X1 11 CNT + 0.00 PRESET AMT @5.00 CLERK 0 NO.000012 TIME 12:28 9999 </pre>		<p>Activity counter 100 and will decrease</p>

D. PLU LINK PROGRAMMING

The following procedure is used to link two or more PLUs.
The second PLU will follow automatically when first is registered.

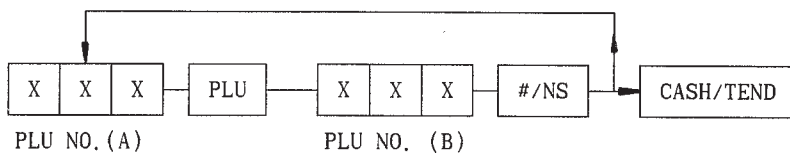

PLU NO. (A)

PLU NO. (B)

Link (A) PLU to (B) PLU

E. REMOVING OR DELETING A PLU

In order to "de-activate" a PLU, or remove its status and department link.

Deleted or inactivated plus will not be allowed to register.

1. Enter the PLU number(1 - 300), and press " PLU " key.
2. Depress the " VOID " key.

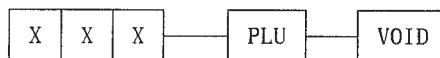

NOTE : PLU'S WITH A TOTAL MAY NOT BE MADE VOID.
TAKE A " Z MODE " PLU REPORT BEFORE VOIDING ANY PLU.

* % KEY PROGRAMMING *

ER-4615 has two % keys (% 1 and % 2) and ER-4640 has four % keys (% 1, % 2, % 3, % 4).

These keys can be programmed as follows :

- Preset percentage discount or surcharge keys.
or
- Preset amount discount keys.
or
- Manual entry amount discount(COUPON) keys.
or
- COUPON 2 keys. @

A. PERCENT KEY PROGRAMMING

* PROGRAMMING STATUS

PROGRAMMING OPTION		VALUE		OPTION DIGIT
COUPON 2 feature		YES = 1 NO = 0		N 1
Discount / surcharge is	POSITIVE	a	1	N 2
	NEGATIVE		0	
	OPEN	b	2	= a + b
	PRESET		0	
Discount / surcharge is	SALE	a	1	N 3
	ITEM		0	
	AMOUNT(COUPON)	b	2	
PERCENTAGE		0		
	INACTIVE	c	4	
	ACTIVE		0	

NOTE : @ COUPON 2 FEATURE : REGISTRATION FOR THIS COUPON WILL AFFECT THE COUPON TOTALIZERS AS THE COUPON AMOUNT.

THIS MEANS THAT THE REGISTERED COUPON AMOUNT IS NOT DEDUCTED FROM THE DEPARTMENT, PLU OR GROSS TOTALIZER, BUT FROM THE NET TOTALIZER ONLY.

IF THE % KEY STATUS = 002 OR 022, IT WILL FUNCTION AS A COUPON KEY. ALSO, IF THE VALUE FOR N2 (DIGIT 2) IS 1 OR 3, THEN VALUES FOR N3(DIGIT 3) OF 2 AND 3 ARE NOT ALLOWED.

* PROGRAMMING

1. Enter the " % " key to be programmed.
2. Enter the three digits % status from the table above and depress the " SUBTOTAL " key.
3. Enter the percentage preset or HALO (up to 4 digits/decimal fixed at two places), and depress the " CASH/TEND " key.

EX) PERCENT RATE : 10 % would be 1 0 0 0
5.6 % would be 5 6 0

* Key sequence

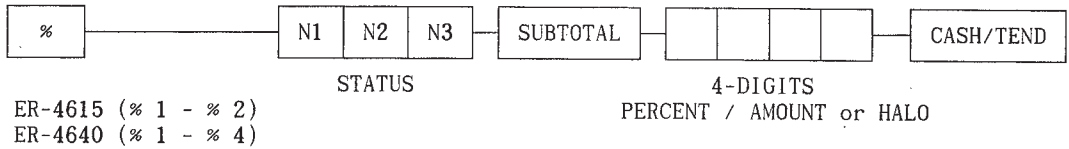

B. PERCENT CALCULATION ROUNDING FACTOR

Refer to SYSTEM OPTION ADDRESS 29 (Page 40).

* CASH/TEND KEY PROGRAMMING

* PROGRAMMING STATUS

PROGRAMMING OPTION	VALUE		OPTION DIGIT
Amount tender and validation are not compulsory on cash tender, and under tender is allowed.	a	0	N 1 = a+b+c+d
Amount tender is compulsory on cash tender.	b	1	
Under tendering is not allowed	c	2	
Validation is compulsory	d	4	

* PROGRAMMING

1. Depress the " CASH/TEND " key.
2. Enter the desired status for option N1 from the list above. Depress the " SUBTOTAL " key.
3. To finalize the CASH/TEND key programming, depress the "CASH/TEND " key.

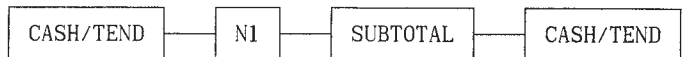

*** CHECK KEY PROGRAMMING ***

*** PROGRAMMING STATUS**

PROGRAMMING OPTION	VALUE		OPTION DIGIT
Amount tender is not compulsory on check tender, and under tender is allowed.	a	0	- N 1
Amount tender is compulsory on check tender.	b	1	= a + b + c
Under tendering is not allowed	c	2	

*** PROGRAMMING**

1. Depress the " CHECK " key.
2. Enter the first HALO amount (0 - 999999, 0 for no HALO) for check tender allowed. Press the " #/NS " key.
3. Enter the second HALO amount (0 - 999999, 0 for no HALO) for over tendering. Press the " X/TIME " key.
4. Enter the desired status for options N1 from the lists above. Depress the " CHECK " key.

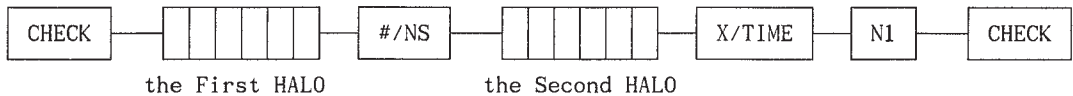

*** CHARGE 1 & 2 KEY PROGRAMMING ***

*** PROGRAMMING STATUS**

PROGRAMMING OPTION	VALUE		OPTION DIGIT
Non-add number entry is not compulsory on charge tender	a	0	N 1
Non-add number entry is compulsory on charge tender	b	1	= a + b

*** PROGRAMMING**

1. Depress the " CHARGE " key to be programmed.
2. Enter the HALO amount (0 - 999999, 0 for no HALO) for charge tender allowed. Press the " #/NS " key.
3. Enter the desired status for options N1 from the lists above. Depress " SUBTOTAL " key.
4. Depress the " CHARGE " key previous entered.

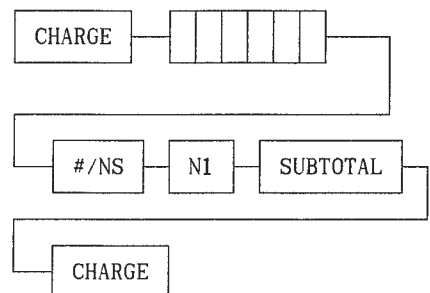

*** PRESET CASH KEY PROGRAMMING ***

1. Depress the " PRESET CASH " key to be programmed.
2. Enter the desired amount(0 - 999999) for preset cash.
3. Depress the " PRESET CASH " key previous entered.

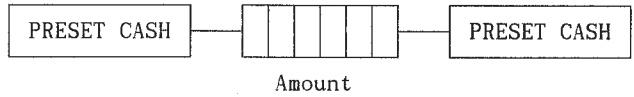

*** CASH IN DRAWER LIMIT PROGRAMMING ***

1. Enter total amount of cash and checks allowed to be in the cash drawer at one time.
2. Depress the " #/NS " key.
3. Depress the " CASH/TEND " key.

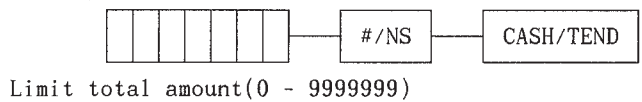

NOTE : IF THE CASH-IN-DRAWER LIMIT IS EXCEEDED, AN ERROR TONE WILL SOUND.
THE CLEAR KEY WILL STOP THE ERROR TONE.

*** CURRENCY CONVERSION KEY PROGRAMMING ***

SETTING THE EXCHANGE RATE :

The foreign exchange rate is determined based on a six digit code entered during this programming step.
Numbers N1 - N5 contain the numeric value of the exchange rate.
N6 sets the decimal point position(0-5).

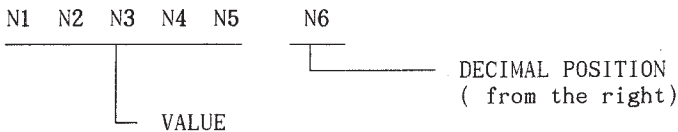

1. Depress the " CONV " key to be programmed.
2. Enter the six digit rate code, press the " SUBTOTAL " key.
3. Press the same " CONV " key.

EX) £1.00 = 2.4455DM

The program code for this exchange rate would be 2 4 5 5 5 4 , giving a numeric value of 24455 with four numbers after the decimal point.

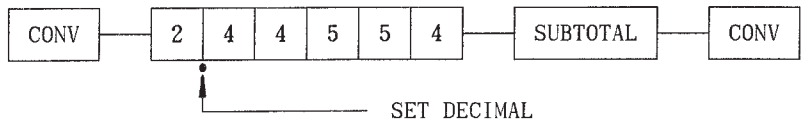

* SYSTEM OPTION PROGRAMMING *

1. Enter up to 2-digit address number, depress the " X/TIME " key.
2. Enter up to 2-digit status number, depress the " SUBTOTAL " key.

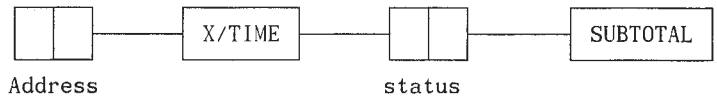

NOTE : ADDRESS 1 - 9 SHOULD NOT BE ENTERED 01 - 09, ONLY ENTER SINGLE DIGIT 1 - 9.
THE VALUE '0' IS DEFAULT STATUS.

ADDRESS	OPTION	VALUE		STATUS
1	Subtotal without tax will print on receipt and journal. Does not require depression of the SUBTOTAL key.	a	YES = 1 NO = 0	a
2	Single item total print.	a	YES = 0 NO = 1	a
3	Inhibit GRAND total print on financial report.	a	YES = 1 NO = 0	a
4	Skip media totals with zero activity on financial report.	a	YES = 0 NO = 1	a
5	Inhibit Time print on receipt and journal.	a	YES = 1 NO = 0	SUM = a+b+c
	Inhibit machine no. print on receipt and journal.	b	YES = 2 NO = 0	
	Inhibit Z report issuing counter print on receipt and journal.	c	YES = 4 NO = 0	
6	Inhibit Date print on receipt and journal.	a	YES = 1 NO = 0	SUM = a + b
	Inhibit consecutive no. print on receipt and journal.	b	YES = 2 NO = 0	
7	The date format will print as: Month, Day, and year =	a	0	SUM
	Day, Month, and year =		1	
	Year, month, and day =		2	
	Check validation amount is: Amount tendered =	b	4	= a + b
	Amount of sale =		0	
8	Inhibit printing of positive department and PLU entries on journal. (Journal skip)	a	YES = 1 NO = 0	SUM
	Print PLUs and Dept.s with zero totals on report issuing.	b	YES = 2 NO = 0	= a + b

ADDRESS	OPTION	VALUE		STATUS
9	Tax symbol print for item.	a	YES = 0 NO = 1	SUM = a+b+c
	VAT PERCENT rate is printed when VAT break down.	b	YES = 2 NO = 0	
	NET SALE amount is printed by automatically VAT breakdown.	c	YES = 4 NO = 0	
10	Decimal for print and display: No decimal = Set at one places = Set at three places = Set at two places =	a	1 2 3 0	a
11	Print media totals on cashier report. (See a clerk report section)	a	YES = 1 NO = 0	a
12	Print sales % on Dept./PLU reports	a	YES = 1 NO = 0	a
13	Cash declaration is compulsory before taking x/z reports.	a	YES = 1 NO = 0	a
14	Voids are allowed in the 'X' control lock position only.	a	YES = 1 NO = 0	SUM = a+b+c
	Compulsory validation on Voids.	b	YES = 2 NO = 0	
	Allowed multiple validations and buffered receipt.	c	YES = 4 NO = 0	
15	Cancel function is allowed in the 'X' control lock position only.	a	YES = 1 NO = 0	a
16	Merchandise returns are allowed in the 'X' control lock position only.	a	YES = 1 NO = 0	SUM = a + b
	Merchandise returns require validation.	b	YES = 2 NO = 0	
17	% key operations are allowed in the 'X' control lock position only	a	YES = 1 NO = 0	SUM = a + b
	% key operations require validation.	b	YES = 2 NO = 0	
18	R/A, and P/O are allowed in the 'X' control lock position only	a	YES = 1 NO = 0	SUM = a + b
	R/A, P/O operations require validation.	b	YES = 2 NO = 0	

ADDRESS	OPTION	VALUE		STATUS	
19	Consecutive number resets after Z1 financial report.	a	YES = 1 NO = 0	SUM = a + b	
	Check key operations require validation.	b	YES = 2 NO = 0		
20	GRAND total resets after Z1 financial report.	a	YES = 1 NO = 0	SUM = a+b+c	
	Charge 1 operations require validation.	b	YES = 2 NO = 0		
	Charge 2 operations require validation.	c	YES = 4 NO = 0		
21	Negative and zero sales total are not allowed.	a	YES = 1 NO = 0	a	
22	Disable No sale function.	a	YES = 1 NO = 0	SUM = a + b	
	Inhibit No sales after non-add number entry.	b	YES = 2 NO = 0		
23	Validation is compulsory with Add check operation.	a	YES = 1 NO = 0	SUM = a + b	
	HASH Department & PLU operations add to NET sales.	b	YES = 2 NO = 0		
24	Compulsory drawer is not activated.	a	YES = 1 NO = 0	a	
25	Enter the HALO (number of digits) for the total amount allowed for R/A and P/O transactions.	a	0.01 - 0.09 =	1	a
			0.01 - 0.99 =	2	
			0.01 - 9.99 =	3	
			0.01 - 99.99 =	4	
			0.01 - 999.99 =	5	
			0.01 - 9999.99 =	6	
			0.01 - 99999.99 =	7	
26	Clerks are	a	Pop-up = 1 Stay down = 0	SUM = a+b+c	
		b	Secret sign-on code = 2 Push button = 0		
		c	Cleak change allowed during registration = YES = 4 NO = 0		

ADDRESS	OPTION	VALUE	STATUS
27	Inhibit check cashing feature.	a YES = 1 NO = 0	SUM
	Check cashing allowed in the 'X' control lock position only.	b YES = 2 NO = 0	= a + b
28	Select the currency logo Other logo (Refer to the page 23 "CODE TABLE ")	Default = ■ a 0 CODE	a
29	% and tax calculation will	round up at 0.50 = always round up = always round down =	a 0 1 2
30	Rounding factor for split pricing and decimal multiplication calculation will	round up at 0.50 = always round up = always round down =	a 0 1 2
31	Tax is figured by INCLUSIVE VAT. Tax is figured by EXCLUSIVE VAT.	a 0 1	a
32	Allow the post tender function.	a YES = 1 NO = 0	a
33	Enforce Non-add number key entry at beginning of sale.	a YES = 1 NO = 0	a
34	Number of digits required for Non-add number entry. (0 allows any length, 1-7 digit)	a 0 1 - 7	a
35	Disable Department/PLU preset override.	a YES = 1 NO = 0	a
36	European round is activated	a YES = 1 NO = 0	a
	0.00 - 0.02 = 0.00		
	0.03 - 0.07 = 0.05		
	0.08 - 0.09 = 0.10		
37	The date format in validation will print as :	a 0 1 2	a
	Month - Date - Year =		
	Date - Month - Year =		
	Year - Month - Date =		
38	Validation sensor is activated.	a YES = 1 NO = 0	a
39	Only stamp will print on the receipt. =	a 0	a
	Both stamp and receipt front message will print on the receipt. =	1	
	Only Receipt front message will print on the receipt. =	2	

* PARAMETERS PROGRAM SCAN *

1. Press the " CASH/TEND " key.
- 2 Press the " SUBTOTAL " key.



Sample receipt of parameter program scanning:

<pre> ***** MISCELLANEOUS SCAN ***** TAX1 RATE 10.000% TAX2 RATE 8.000% TAX3 RATE 6.000% TAX4 RATE 5.000% ----- Z 1 RATE -10.00% Z 1 STAT 0 Z 2 COUPON AMT -5.00 Z 2 STAT 2 Z 3 RATE 5.00% Z 3 STAT 10 Z 4 MINUS AMT -5.00 Z 4 STAT 100 ----- CASH STAT 0 CHK HALO1 =0.00 CHK HALO2 =0.00 CHECK STAT 0 CHG1 HALO =0.00 CHG1 STAT 0 CHG2 HALO =0.00 CHG2 STAT 0 DWR LIMIT AMT =0.00 ----- CONV1 RATE #2.4455 CONV2 RATE #0.00 ----- CLK1 CODE 12345 CLK1 DRAWER 0 CLK2 CODE 23456 CLK2 DRAWER 0 CLK3 CODE 34567 CLK3 DRAWER 0 CLK4 CODE 45678 CLK4 DRAWER 0 </pre>	<pre> Preset cash 1 amount ----- System options ----- % 1 programming ----- % 2 key programming ----- ER-4640 Only ----- Cash key programming ----- Check key first HALO programming ----- Check key second HALO programming ----- Check key status programming ----- Chargel key programming ----- Cash in drawer limit amount ----- Currency conversion key programming ----- Clerk secret code ----- Clerk drawer assignment </pre>	<pre> ----- PRECASH1 AMT =5.00 PRECASH2 AMT =10.00 PRECASH3 AMT =20.00 ----- SYSTEM OPN 4 1 SYSTEM OPN 12 1 SYSTEM OPN 13 1 SYSTEM OPN 26 2 SYSTEM OPN 32 1 ----- TRAIN MD CODE 1111 CLERK 0 NO.000014 TIME 12:43 9999 </pre>
--	--	---

INSTRUCTION TO THE OPERATIONS MANUAL

The operation manual is designed to show you how to operate ECR during normal use. The manual also has a section on gathering report and balancing the cash register.

The operation manual uses flow charts similar to those in the programming manual. Each labeled box represents a key you should press to complete an operation.

Receipt tapes accompany some of the flow charts. These tapes will help you to interpret the receipts your machine issues.

Unless otherwise noted, the flow charts use the " CASH/TEND " key to finalize the sale. The majority of the flow charts assume the custom tenders the correct amount, so change calculation are skipped.

NOTE

A cashier must be signed on before operation can take place. The register will not operate in register mode unless a clerk key has been signed on. This only requires that a clerk key be depressed in the 'REG' mode.

To sign a clerk off, thereby displaying the "CLOSEd" message on the display, enter the " 0 " (zero) key followed by a depression of the " CLERK " key being signed off. This effectively disables the register until a clerk key is depressed to sign on.

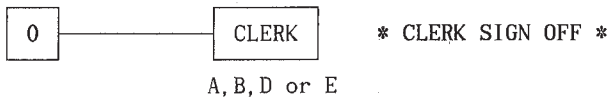

* ALL REGISTRATIONS ARE MADE IN THE " REG " OR " VOID " CONTROL LOCK POSITION.

* CLERK SING ON *

This ECR has two sign on method, the first is the push button sign on method and the second is the secret code sign on method.

A. PUSH BUTTON SIGN ON

Press one of the clerk keys (A,B,D,E) to start operation the cash register.

CLERK

B. SECRET CODE SIGN ON

If ADDRESS 26 VALUE 'b' of SYSTEM OPTION PROGRAMMING (Page 39) is programmed, then a clerk secret code must be entered to start the operation.

The clerk secret code is programmed in clerk secret code programming. Enter the clerk secret code as follows, the code will not be shown.

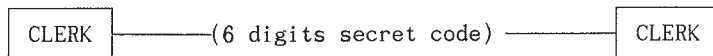

* According to the VALUE 'a' of ADDRESS 26, a clerk must be entered before each transaction And if ADDRESS 26 VALUE 'c' is programmed, clerk change will be allowed during registration.

*** CLEARING AN ERROR CONDITION ***

CLEAR

If the error tone is ringing, press

There are several ERROR prompt symbols. A prompt symbol appears on the left side of the display when a mis-operation occurs or when a compulsory operations must be performed. Refer to ' * DISPLAY SYMBOLS *' (Page 13).

*** NO SALE OPERATIONS ***

A no sale operation opens the cash drawer outside of a sale.

#/NS

*** NON-ADD NUMBER ENTRIES ***

The " #/NS " key can be used to enter up to seven digits. This numeric entry will add to non-add numeric total.



```

DATE 12.25.'93  SUN
NO SALES -----
CLERK 1      NO.000021
TIME 12:44   9999
    
```

```

NON-ADD #  1234567
    
```

* NO SALE *

* NON- ADD NUMBER *

*** DEPARTMENT ENTRIES ***

A. OPEN DEPARTMENT ENTRIES

1) Single open DEPARTMENT entry



Enter amount

2) Repeat open DEPARTMENT entry



Enter amount

3) Multiple open DEPARTMENT entry



Enter Q'ty(1-99)

Enter amount

4) Decimal multiplication of open DEPARTMENT entry

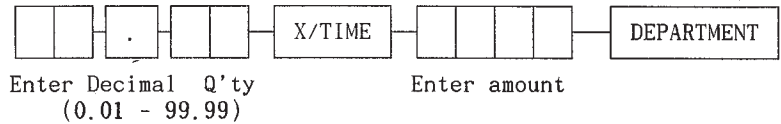

5) Override HALO price entry

The High Amount Lock Out (HALO) limits the amount entered.

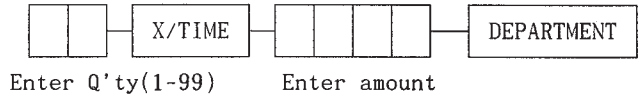

6) Split pricing on open DEPARTMENT entry

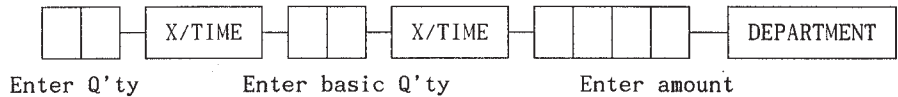

	DATE 12.25.'93	SUN	
Dept. 1	APPLE X1	-10.00	Taxable by tax 1
descriptor	APPLE X1	-10.00	Repeat entry
	APPLE X1	-10.00	
	3X	@10.00	Multiple open entry
	APPLE X1	-30.00	
	1.5X	@10.00	Decimal multiplication
	APPLE X1	-15.00	
	1X	@100.00	HALO override
	APPLE X1	-100.00	
	3/4FOR	@10.00	Split pricing
	APPLE X1	-7.50	
	TOTAL	-182.50	
	CASH	-182.50	
	CLERK 1	NO.000022	
	TIME 12:47	9999	

B. PRESET DEPARTMENT ENTRIES

1) Single preset amount DEPARTMENT entry



2) Repeat preset amount DEPARTMENT entry



3) Multiple preset amount DEPARTMENT entry

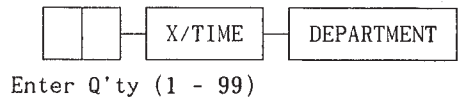

4) Decimal multiplication of preset amount DEPARTMENT entry

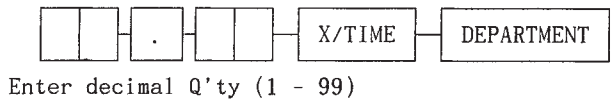

5) Override preset amount price entry

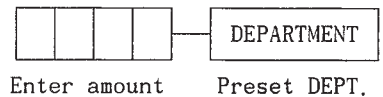

6) Split pricing on preset amount DEPARTMENT entry

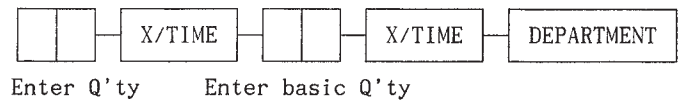

	DATE 12.25.'93	SUN	
Dept. 3	DEPT.3 X2	-10.00	— Preset price taxable by tax 2
	DEPT.3 X2	-10.00	— Repeat entry
	DEPT.3 X2	-10.00	
	3X	@10.00	— Multiplication
	DEPT.3 X2	-30.00	
	1.5X	@10.00	— Decimal multiplication
	DEPT.3 X2	-15.00	
	DEPT.3 X2	-20.00	— Preset override
	3/4FOR	@10.00	— Split pricing
	DEPT.3 X2	-7.50	
	TOTAL	-102.50	
	CASH	-102.50	
	CLERK 1	NO.000023	
	TIME 12:48	9999	

C. GALLONAGE DEPARTMENT OPERATION

Selection of the gallonage option in the department programming section causes a number of things to happen.

First of all, although gallonage departments are considered open departments, a per gallon price must be entered as part of the department programming. This price is calculated to three decimal points. (e.g. 1.399).

Secondly, although gallonage departments are programmed as a preset price, you must enter amounts when gallonage departments are registered.

* DEPT.10 has been programmed for gallonage status, and is non-taxable with a unit price 1.399.

EX)

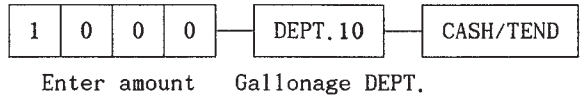

DATE 12.25.'93	SUN
GAL CNT	#7.15
GAL AMT	@1.399
DEPT.10	-10.00
TOTAL	-10.00
CASH	-10.00
CLERK 1	NO.000024
TIME 12:48	9999

- Calculated gallonage counter
- Gallonage price
- Gallonage dept. 10

* PLU (PRICE LOOK UP) ENTRIES *

A. OPEN PLU ENTRIES

1) Single open PLU entry



2) Repeat open PLU entry

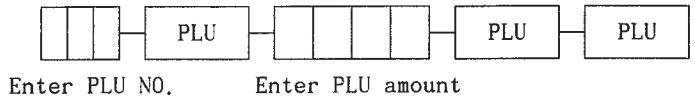

3) Multiple open PLU entry

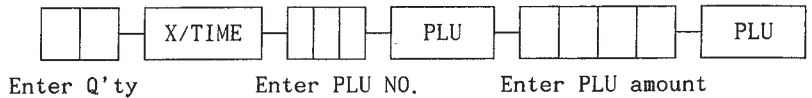

4) Decimal multiplication of open PLU entry

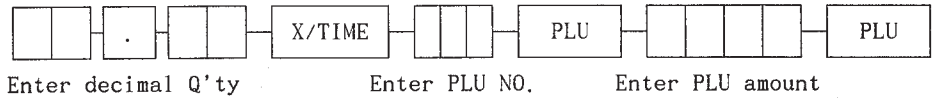

5) Override HALO price entry

The High Amount Lock Out (HALO) limits the amount entered.

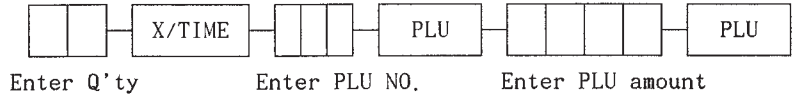

6) Split pricing on open PLU entry



PLU NO. 10
descriptor

DATE 12.25.'93	SUN
ORANGE X1	-10.00
ORANGE X1	-5.00
ORANGE X1	-5.00
3X	@5.00
ORANGE X1	-15.00
1.5X	@10.00
ORANGE X1	-15.00
1X	@100.00
ORANGE X1	-100.00
3/4FOR	@10.00
ORANGE X1	-7.50
TOTAL	-157.50
CASH	-157.50
CLERK 1	NO.000025
TIME 12:49	9999

- PLU price taxable by tax 1
- Repeat entry
- PLU multiplication
- Decimal multiplication
- PLU HALO override
- Split pricing

B. PRESET PLU ENTRIES

1) Single preset PLU entry



Enter PLU NO.

2) Repeat preset PLU entry

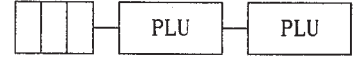

Enter PLU NO.

3) Multiple preset PLU entry



Enter Q'ty

Enter PLU NO.

4) Decimal multiplication of preset PLU entry

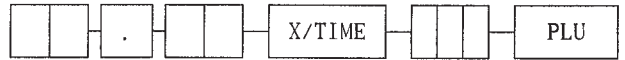

Enter decimal Q'ty

Enter PLU NO.

5) Split pricing on preset PLU entry

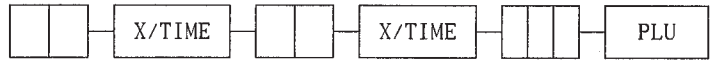

Enter Q'ty

Enter basic Q'ty

Enter PLU NO.

	DATE 12.25.'93	SUN	
PLU NO. ———	PLU 20 X 2	-10.00	——— PLU price taxable by tax 2
	PLU 100 X 1	-5.00	——— Repeat entry
	PLU 100 X 1	-5.00	
	3X	@10.00	——— PLU multiplication
	PLU 20 X 2	-30.00	
	1.5X	@10.00	——— Decimal multiplication
	PLU 20 X 2	-15.00	
	3/4FOR	@10.00	——— Split pricing
	PLU 20 X 2	-7.50	
	TOTAL	-72.50	
	CASH	-72.50	
	CLERK 1	NO.000028	
	TIME 12:53	9999	

C. PLU TO PLU CHAIN OPERATION

All Preset PLU's in the same chain(PLU to PLU linking) will automatically ring up when the first PLU of the PLU chain is entered. If a PLU located in the middle of the PLU chain is entered, all Preset PLU's futher down on the chain will automatically ring up.

* PLU 100 is linked to PLU 50.

DATE 12.25.'93	SUN	
PLU 50 X1	-10.00	
PLU 100 X1	-5.00	Chain PLU
TOTAL	-15.00	Preset price of 5.00
CASH	-15.00	
CLERK 1	NO.000029	
TIME 12:53	9999	

* SINGLE ITEM DEPARTMENT OR PLU ENTRIES *

Single item operation is finalized transaction without tendering key entry. But the transaction is not finalized when you press a department or PLU key before single item department or PLU entry.

A. SINGLE ITEM PRESET ENTRY

DEPT. or PLU

B. SINGLE ITEM OVERRIDE ENTRY

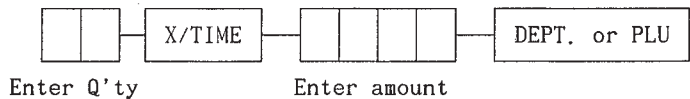

DATE 12.25.'93	SUN	
DEPT.4 X3	-15.00	Single item dept.
TOTAL	-15.00	
CASH	-15.00	
CLERK 1	NO.000030	
TIME 12:54	9999	

* COMPUTATION OF VAT (Value Added Tax) *

The following four tax systems are available on your register. You can select any of them depending on your requirements.

NOTE : REFER TO SYSTEM OPTION ADDRESS 31 TO SELECT INCLUSIVE OR EXCLUSIVE VAT.

1. VAT 1 - 4 system (INCLUSIVE VAT)

This system provides the VAT calculation for taxable 1-4 subtotals. This calculation is performed using the corresponding programmed percentage when the " VAT " key is pressed just after the " SUBTOTAL " key.

2. VAT 1 - 4 system (EXCLUSIVE VAT)

Calculates taxes for 1 - 4 subtotals by using the corresponding programmed percentage, and also the calculated taxes to those subtotals, respectively.

Value Added Tax (VAT)

The VAT routine is as follow. The breakdown of tax that has been charged to an item(s) is determined and prints in a unique format at the end of the receipt. Following the subtotal of the sale, to do this depress the " VAT " key.

A. INCLUSIVE VAT

1) Inclusive VAT is used when a tax is already included in the item price, and a breakdown of the various tax charge is separated out.

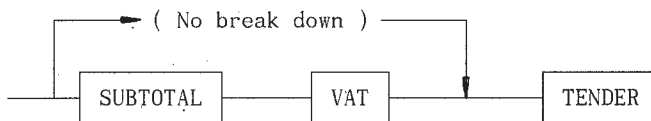

When you use SYSTEM OPTION ADDRESS 9 VALUE 'c' (Page 38), breakdown will be done automatically.

2) VAT shift

When the " VAT SHIFT " key entry is made for a particular department or PLU programmed for taxable 1, their tax status shifts to taxable 2.

When this entry is made for a particular department or PLU programmed for taxable 1 and taxable 3, the tax status taxable 1 remains unchanged, but the taxable 3 shifts to tax delete.



B. EXCLUSIVE VAT

1) When you use EXCLUSIVE VAT, you should program SYSTEM OPTION ADDRESS 31 to 1.

Exclusive VAT is used when tax has not been previously incorporated into the item price, and the appropriate automatic tax rate are applied at the end of sales.

2) Tax Exempt

While the EXCLUSIVE VAT routine is in use, you can exempt normally taxable department or PLU entries from tax.

For this purpose, the " VAT SHIFT " key is used as a tax exempt key.



DATE 12.25.'93	SUN	
APPLE X1	10.00	— Taxable by tax 1
APPLE X2	10.00	— Tax 1 shift
DEPT.6 X1&3	10.00	— Taxable by tax1
DEPT.6 X1	10.00	— and tax 3
SUBTOTAL	40.00	— Tax 3 delete
TAXABLE 1	30.00	— Tax1 taxable amount
NET1 AMT	27.27	— Tax1 break down
TAX1 AMT	2.73	
TAXABLE 2	10.00	— Tax2 taxable amount
NET2 AMT	9.26	— Tax2 break down
TAX2 AMT	0.74	
TAXABLE 3	10.00	— Tax3 taxable amount
NET3 AMT	9.43	— Tax3 break down
TAX3 AMT	0.57	
TOTAL	40.00	
CASH	40.00	
CLERK 1	NO.000033	
TIME 13:22	9999	

DATE 12.25.'93	SUN	
SYSTEM OPN 31	1	
APPLE X1	10.00	— Taxable by tax 1
APPLE	10.00	— Tax 1 exempt
DEPT.3 X2	10.00	— Taxable by tax 2
DEPT.3	10.00	— Tax 2 exempt
DEPT.4 X3	15.00	— Taxable by tax 3
DEPT.4	15.00	— Tax 3 exempt
DEPT.15 X4	10.00	— Taxable by tax 4
DEPT.15	10.00	— Tax 4 exempt
SUBTOTAL	90.00	
TAX1 AMT	1.00	— Tax 1 amount
TAX2 AMT	0.80	— Tax 2 amount
TAX3 AMT	0.90	— Tax 3 amount
TAX4 AMT	0.50	— Tax 4 amount
TOTAL	93.20	
CASH	93.20	
CLERK 1	NO.000034	
TIME 13:23	9999	

SYSTEM OPTION
ADDRESS 31

* INCLUSIVE VAT *

* EXCLUSIVE VAT *

* % KEY ENTRIES *

A. DISCOUNT/SURCHARGE OPERATION

You can register a percentage discount or surcharge using the % key. Whether the % key register a discount or surcharge depends on the programming, so in this section the operations are referred to as Discount/Surcharge. The discount or surcharge may be open preset and may be programmed to apply to items, or to apply to the entire sale (entered after a " SUBTOTAL " key).

1) Preset percent item discount/surcharge

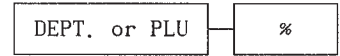

2) Overriding preset item discount/surcharge

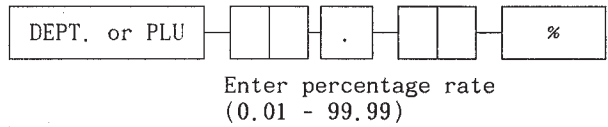

3) Preset percent sale discount/surcharge

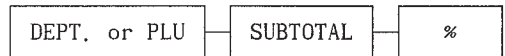

4) Open sale discount/surcharge

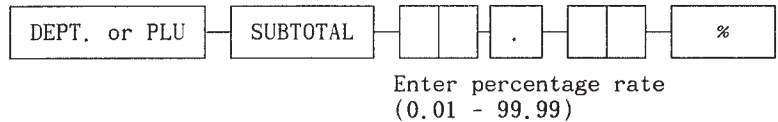

DATE 12.25.'93	SUN	
APPLE X1	-10.00	
DISCOUNT 1	-10.00%	— Preset % discount
AMOUNT	-1.00	
APPLE X1	-10.00	
SURCHARGE 3	5.00%	— Preset % surcharge
AMOUNT	0.50	
DEPT.3 X2	-10.00	
DISCOUNT 1	-15.50%	— Override preset % discount
AMOUNT	-1.55	
TOTAL	27.95	
CASH	27.95	
CLERK 1	NO.000037	
TIME 13:28	9999	

DATE 12.25.'93	SUN	
APPLE X1	-10.00	
APPLE X1	-10.00	
SALE DISC 2	-5.00%	— Preset % sale discount
AMOUNT	-1.00	
APPLE X1	-10.00	
DEPT.3 X2	-10.00	
SALE DISC 4	-15.50%	— Open -% sale discount
AMOUNT	-6.05	
TOTAL	32.95	
CASH	32.95	
CLERK 1	NO.000039	
TIME 13:30	9999	

B. COUPON (PRESET/OPEN AMOUNT DISCOUNT) OPERATION

The coupon or Preset/Open amount discount allows you to reduce the total amount of sale by the amount.
 You must enter the coupon key after the items, not before, coupon must be linked to appropriate department or PLU.

1) Coupon (Preset/Open amount discount) item entry

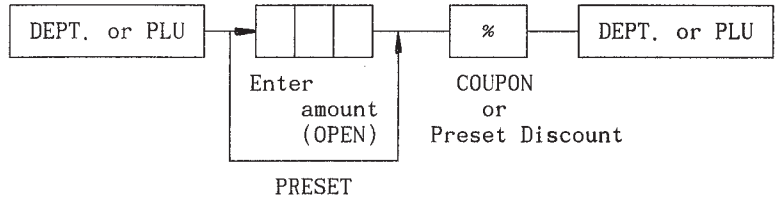

2) Multiple coupon item entry

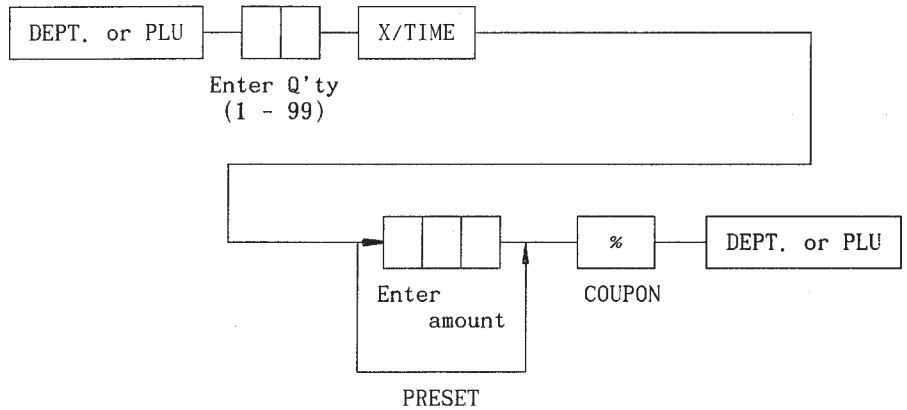

3) Preset coupon override on item

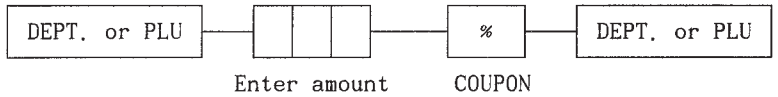

4) HALO override on item coupon

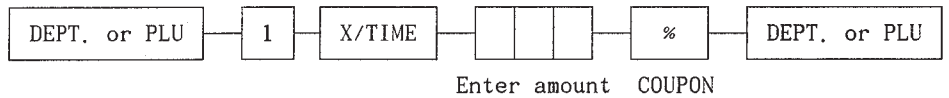

5) Coupon (Preset/Open amount discount) sale entry

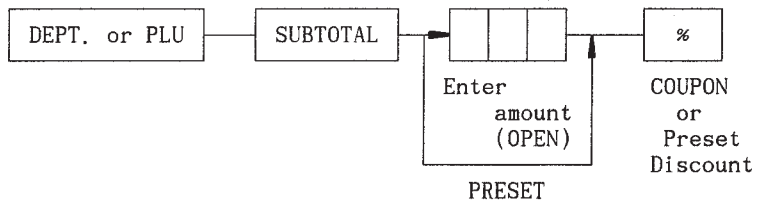

C. COUPON 2 OPERATION

To register this feature, please read ' COUPON 2 FEATURE NOTE ' in programming of COUPON 2.

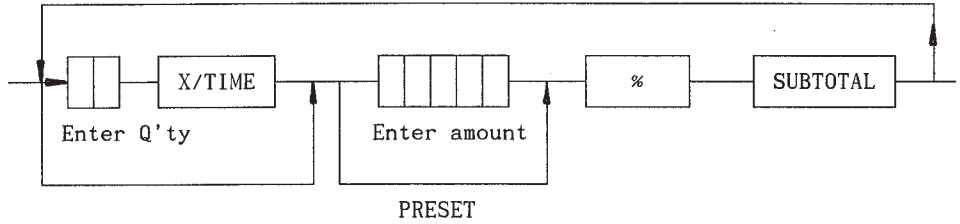

DATE 12.25.'93	SUN
APPLE X1	-10.00
APPLE X1(C)	-0.50
2X	-0.50
APPLE X1(C)	-1.00
APPLE X1(C)	-0.60
1X	-1.00
APPLE X1(C)	-1.00
TOTAL	=6.90
CASH	=6.90
CLERK 1	NO.000041
TIME 13:31	9999

- Coupon entry
- Multiple coupon entry
- Override preset coupon
- HALO overriding coupon

DATE 12.25.'93	SUN
APPLE X1	-10.00
DEPT.3 X2	-10.00
ORANGE X1	-5.00
SALE CPN AMT	-0.50
TOTAL	=24.50
CASH	=24.50
CLERK 1	NO.000042
TIME 13:32	9999

— Sale coupon entry

Direct discount entry —

DATE 12.25.'93	SUN
MINUS AMT	-5.00
MINUS AMT	-0.50
TOTAL	-5.50
CASH	-5.50
CLERK 1	NO.000043
TIME 13:32	9999

* MERCHANDISE RETURN OPERATIONS *

A. MERCHANDISE RETURN OF A SINGLE DEPARTMENT OR PLU ENTRY

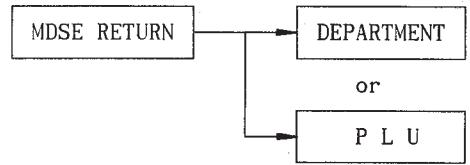

B. MERCHANDISE RETURN OF A MULTIPLE DEPARTMENT OR PLU ENTRY

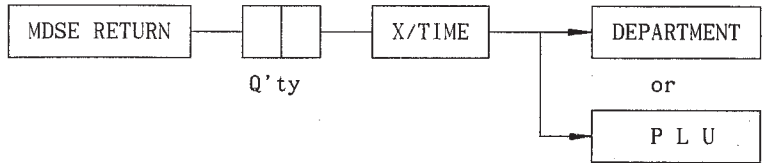

C. MERCHANDISE RETURN OF DISCOUNTED ITEM

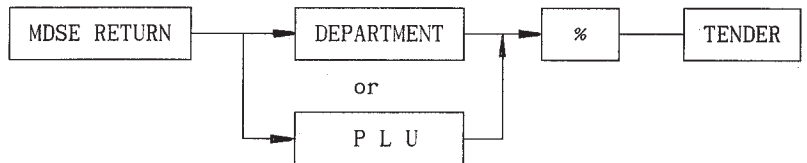

NOTE: MERCHANDISE RETURN OF NEGATIVE DEPARTMENTS OR PLU'S IS NOT ALLOWED ALSO, VOID OF MERCHANDISE RETURN ENTRIES IS NOT ALLOWED.

```

DATE 12.25.'93  SUN
RETURN *****
APPLE X1      -10.00
RETURN *****
2X            -10.00
APPLE X1      -20.00
RETURN *****
APPLE X1      -10.00
DISCOUNT 1  -10.00%
AMOUNT        -1.00
TOTAL         -39.00
CASH          -39.00
CLERK 1      ND.000046
TIME 13:43   9999
  
```

- Single item returned
- Multiple item returned
- Discounted item returned

*** VOID OPERATIONS ***

A. VOID OF A LAST ITEM ENTRY (ERROR CORRECT)

Press the " VOID " key immediately after making an incorrect entry.

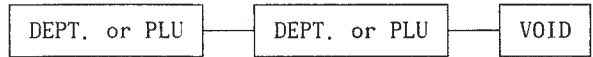

B. VOID OF A PREVIOUS ITEM ENTRY

You can make corrections using the " VOID " key at any point during the sale.

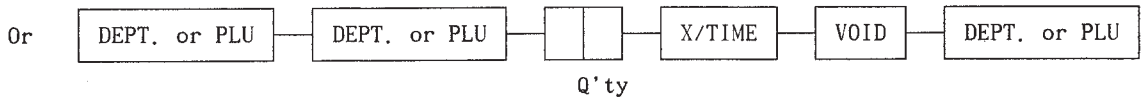
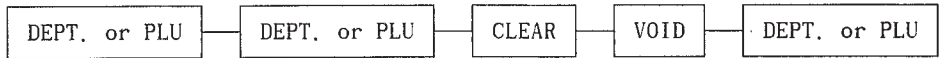

DATE 12.25.'93	SUN
APPLE X1	-10.00
DEPT.3 X2	-10.00
DEPT.4 X3	-15.00
ERROR CORRECT	-----
DEPT.4 X3	-15.00
PREVIOUS VOID	-----
APPLE X1	-10.00
TOTAL	-10.00
CASH	-10.00
CLERK 1	NO.000047
TIME 13:43	9999

————— Error correct

————— Previous void

C. VOID OUTSIDE OF A SALE

If you want to void a number of items of incorrect entries which were not made void during a sale.

- 1) Turn the control lock key to the 'VOID' position.
- 2) Make all entries you want to void in the normal sequence.
- 3) All these items will appear as alternative sign amounts.
- 4) All VOID position operations maintain their own total on the report.

```

DATE 12.25.'93  SUN
VOID MODE *****
DEPT.3 X2      -10.00
APPLE X1       -10.00
TOTAL          -20.00
CASH         -20.00
CLERK 1       NO.000048
TIME 13:44    9999
    
```

Void outside of a sale

D. CANCEL (VOID 4) OPERATION

Depression of the "CANCEL" key anywhere within a transaction cancels the entire transaction. This is not a tender key!

Transactions of up to a maximum of thirty items may be canceled.

If a cancel function is attempted after the entering more than thirty items, the function will error.

The only total updated by this transaction is the 'CANCEL' total which would be the total of all positive entries made in the transaction before the depression of the "CANCEL" key.

The transaction number is advanced as for any transaction.

All other total will be not updated.

```

DATE 12.25.'93  SUN
APPLE X1        =10.00
DEPT.2 X1       =10.00
DEPT.3 X2       =10.00
DEPT.4 X3       =15.00
ALL CANCEL *****
CLERK 1       NO.000049
TIME 13:44    9999
    
```

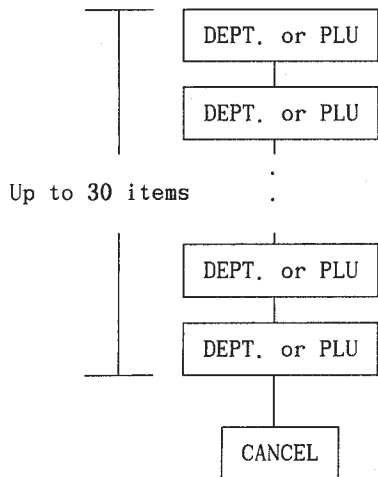

* ADD CHECK OPERATIONS

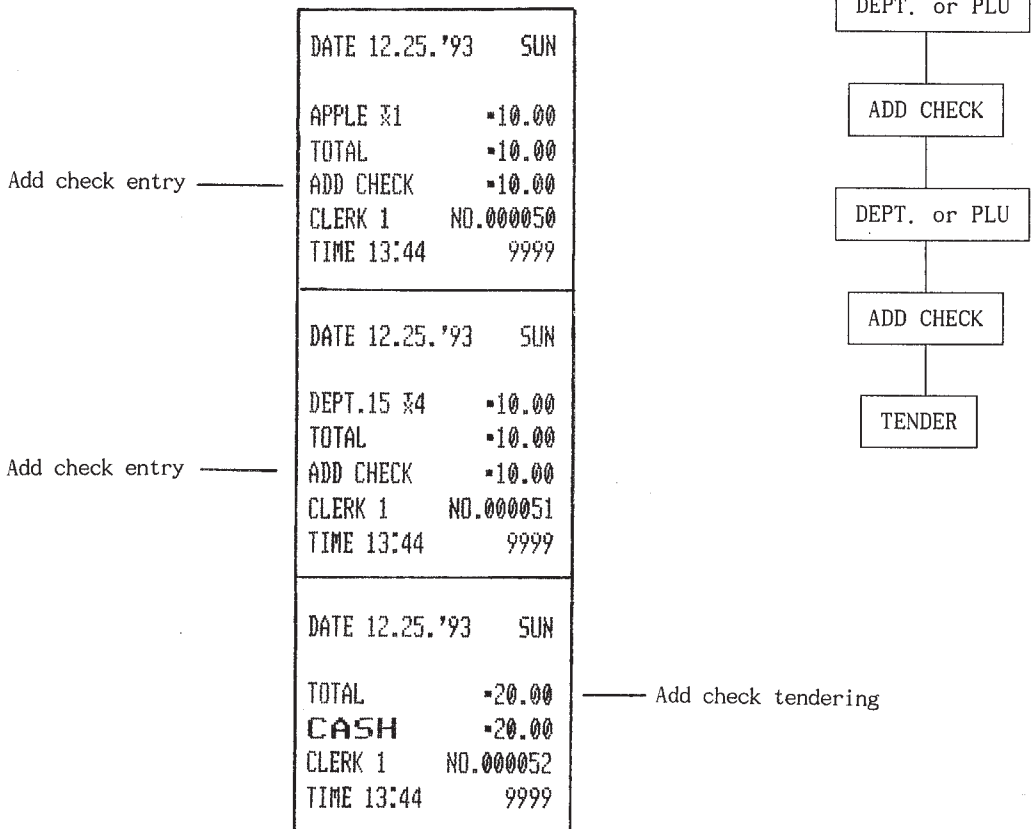

* TENDERING OPERATION *

A. CASH TENDER

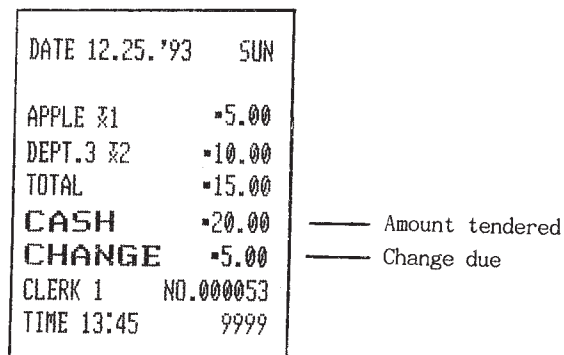
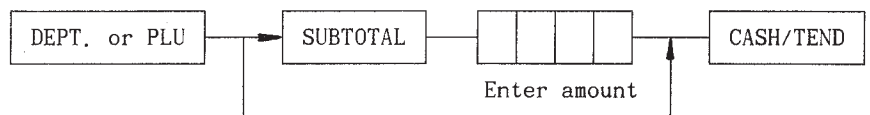

B. PRESET CASH TENDER

You must program the " PRESET CASH ". If you do not program this key, an error will occur when you enter the " PRESET CASH " key.

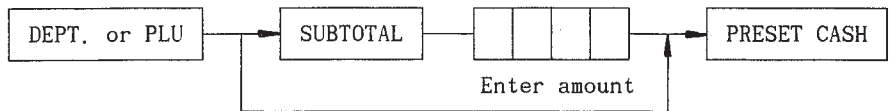

```

DATE 12.25.'93  SUN
APPLE X1      -10.00
DEPT.3 X2    -10.00
TOTAL        -20.00
CASH       -5.00
TOTAL        -15.00
CASH      -10.00
TOTAL         5.00
CASH      -20.00
CHANGE    -15.00
CLERK 1      NO.000054
TIME 13:45   9999
  
```

- Preset cash 1 (Amount 500) entry
- Preset cash 2 (Amount 1000) entry
- Preset cash 3 (Amount 2000) entry
- Change due

C. CHECK TENDER

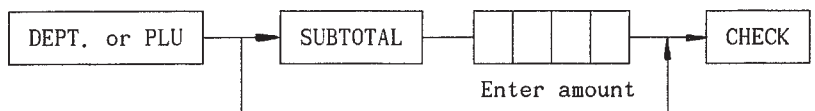

```

DATE 12.25.'93  SUN
APPLE X1      -5.00
PLU 20 X2    -10.00
TOTAL        -15.00
CHECK     -20.00
CHANGE    -5.00
CLERK 1      NO.000056
TIME 13:46   9999
  
```

- Amount of check tendered
- Change due

D. CHARGE TENDER

The entered amount of charge must not be more than subtotal amount.

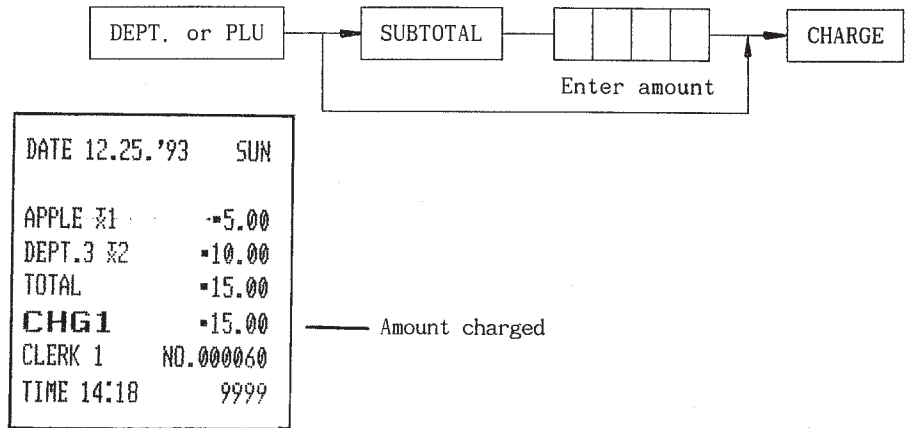

E. SPLIT TENDER

You can register any combination of tendering media on this ECR.

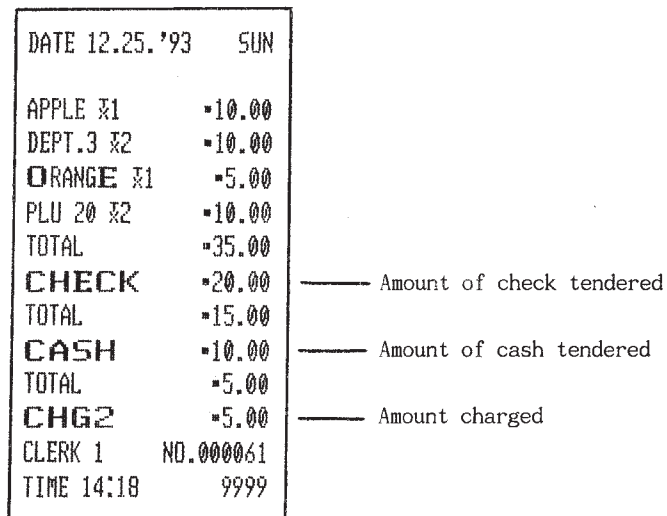
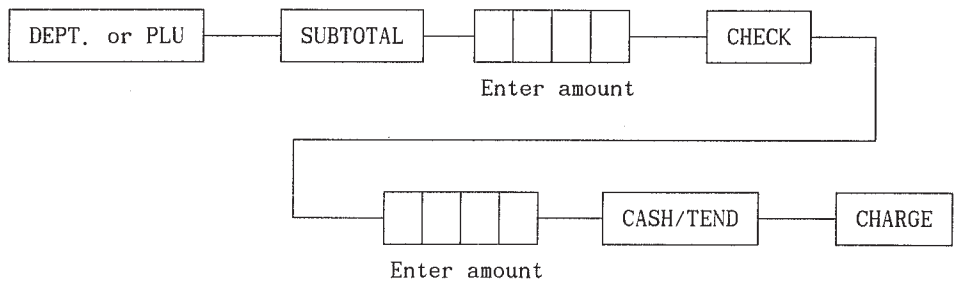

F. TENDERING WITH CURRENCY CONVERSION

You must program the " CONV " key. If you do not program this key, an error will occur when you press the " CONV " key.

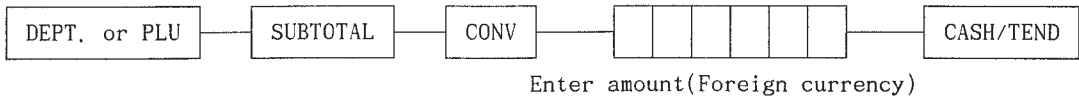

```

DATE 12.25.'93  SUN
DEPT.7          -1.00
TOTAL           -1.00
FOREIGN AMT     @3.00
CHANGE RATE     #2.4455
HOME AMT        -1.23
CHANGE        -0.23
CLERK 1        NO.000062
TIME 14:18     9999
  
```

- Entered foreign currency amount
- Change rate
- Changed home currency
- Change due

G. POST TENDERING

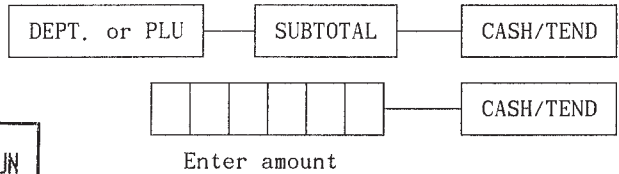

```

DATE 12.25.'93  SUN
APPLE X1        -5.00
DEPT.3 X2       -10.00
TOTAL           -15.00
CASH         -15.00
CLERK 1        NO.000063
TIME 14:19     9999
  
```

NOTE : POST TENDER FUNCTION MUST BE PROGRAMMED SYSTEM OPTION ADDRESS 32 (Page 40) TO OPERATE THIS FUNCTION. POST TENDER FUNCTION IS ALLOWED TO BE USED ON CASH TRANSACTIONS ONLY. AFTER POST TENDERING, THE DISPLAY WILL SHOW THE REMAINING AMOUNT AND THE DRAWER WILL OPEN.

*** CHECK CASHING ***

If a customer wants to cash a check, follow this procedure.

- 1) Enter the amount of the check.
- 2) Press the " CHECK " key.

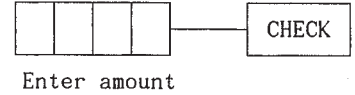

```

DATE 12.25.'93  SUN
* CHECK CASHING *
CHECK          -50.00
CASH           -50.00
CLERK 1       NO.000064
TIME 14:19    9999
    
```

*** RECEIVED ON ACCOUNT OPERATIONS ***

Use the R/A key to register cashes or checks added to the cash drawer.

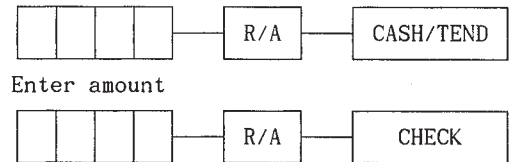

```

DATE 12.25.'93  SUN
R/A             -10.00
CASH            -10.00
CLERK 1       NO.000065
TIME 14:19    9999
    
```

```

DATE 12.25.'93  SUN
R/A             -10.00
CHECK           -10.00
CLERK 1       NO.000066
TIME 14:19    9999
    
```

* Received on account cash *

* Received on account check *

*** PAID OUT OPERATIONS ***

Use the P/O(=PAID OUT) key to register media that is moved from cash drawer.
(Media = cash or check)

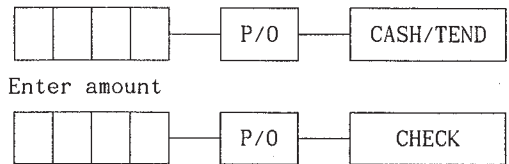

DATE 12.25.'93	SUN
P/O	-5.00
CASH	-5.00
CLERK 1	NO.000067
TIME 14:19	9999

* Paid out cash *

DATE 12.25.'93	SUN
P/O	-5.00
CHECK	-5.00
CLERK 1	NO.000068
TIME 14:19	9999

* Paid out check *

*** PRINTING A BUFFERED RECEIPT OPERATIONS ***

If a customer requests a receipt after a sale has been finalized, and the "RECEIPT ON/OFF" key was in the 'OFF' position during the sale, a second depression of the " CASH/TEND " key will issue a buffered receipt (Up to 30 lines).

A buffered receipt is limited to 20 item lines and 10 tendering lines.

If more than 20 entries are made in the sale, the register will issue a stub receipt only, showing the total net sale, correct tax totals and payment tendered.

NOTE : RECEIPT ON/OFF should be used on 'REG/VOID' position of control lock, and can not be used during transactions.

Press the RECEIPT ON/OFF key once to change it's status.

When the RECEIPT ON/OFF sign is illuminated on display panel, the receipt printer will be turn off.

* VALIDATION OPERATIONS *

First of all, place a check or slip into the slot below the Receipt/Detail printer.

Upon depression of the " VALID " key, validations can be performed on department and PLU entries, R/A and P/O operation, % key entries, merchandise return, voids, and tendering operations.

If an operation is programmed "Validation Compulsory", this ECR will not operate until this is satisfied, and the message ' S P ' will appear on the display. The error tone will sound if any other operations are attempted before the operation is validated.

Validation works only one time.

But if you want more than one validation, you must program SYSTEM OPTION ADDRESS 14 by VALUE 'c' (Page 38).

* SAMPLE VALIDATION RECEIPTS

* RECEIPT SIDE * * JOURNAL SIDE *

1	1225'93	N000068	RTN	APPLE	-10.00
<u> </u>	<u> </u>	<u> </u>	<u> </u>	<u> </u>	<u> </u>
a	b	c	d		e

1	2512'93	N000068	DPT	DEPT.3	10.00
<u> </u>	<u> </u>	<u> </u>	<u> </u>	<u> </u>	<u> </u>
a	b	c	d		e

* Date (b) = SYSTEM OPTION ADDRESS 37 (Page 40) is 1 (DD/MM/YY).

1	'931225	N000068	TND	CASH	10.00
<u> </u>	<u> </u>	<u> </u>	<u> </u>	<u> </u>	<u> </u>
a	b	c	d		e

* Date (b) = SYSTEM OPTION ADDRESS 37 (Page 40) is 2 (YY/MM/DD).

- a = Clerk number.
- b = Date.
- c = Receipt consecutive number.
- d = Registration step.
- e = validated transaction content.

*** TRAINING OPERATIONS ***

First of all, you must program the training mode secret code to operate the training mode operation.

Please refer to '3. TRAIN MODE PROGRAMMING' of 'PROGRAMMING NOTE' in this manual.

1. Turn the control lock key to the 'SERVICE MODE' position with marked 'C' key.
2. Program the train mode secret code for train operation.
This secret code is valid until this secret code is changed.

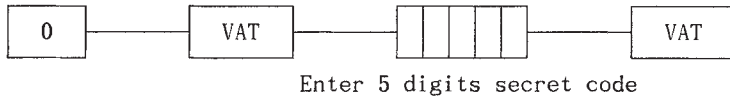

3. Change the normal operation mode to train operation mode.
(NORMAL OPERATION MODE -> TRAIN OPERATION MODE)

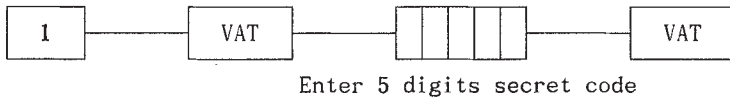

NOTE : After doing step 3, all the amounts registered are accumulated in the training mode report total area and will not effect normal report total areas.

This ECR has 2 separated reports.

One is the training mode reports the other is the normal operation reports.

Training mode report has only daily reports and reset to '0' after 'Z' mode report issuing.

4. To finalize the training mode operation, Enter the following steps in the 'SERVICE MODE' position. (TRAINING OPERATION MODE -> NORMAL OPERATION MODE)



REPORT AND BALANCING

This ECR will produce the following reports.

<u>REPORTS</u>	<u>REPORT NO.</u>	<u>REPORT TYPE</u>	<u>KEY LOCK</u>	<u>KEY SEQUENCE</u>
FINANCIAL REPORT	1	X	X	1 SUB
		Z	Z	1 SUB
		X2	X	201 SUB
		Z2	Z	201 SUB
TIME REPORT	2	X	X	2 SUB
		Z	Z	2 SUB
		X2	X	202 SUB
		Z2	Z	202 SUB
PLU REPORT	3	X	X	3 SUB
		Z	Z	3 SUB
		X2	X	203 SUB
		Z2	Z	203 SUB
CASH-IN-DRAWER REPORT	4	X	X	4 SUB
CHECK-IN DRAWER REPORT	5	X	X	5 SUB
DAILY SALES REPORT	6	X	X	6 SUB
		Z	Z	6 SUB
INDIVIDUAL CLERK REPORT		X	X	SUB CLERK
		Z	Z	SUB CLERK
		X2	X	20 SUB CLERK
		Z2	Z	20 SUB CLERK
FROM/TO DEPT REPORT		X	X	FROM DEPT. KEY TO DEPT. KEY
FROM/TO PLU REPORT		X	X	XXX-PLU XXX-PLU
DEPARTMENT GROUP REPORT	30	X	X	30 SUB
		Z	Z	30 SUB
		X2	X	230 SUB
		Z2	Z	230 SUB

*** REPORT MODES ***

By turning the control lock key to different positions and by altering the key sequence, You may vary which totals are reset to '0' when you print the report.

- * X MODE reports do not reset any totals. The Z counter is not advanced by X mode reports. The cash drawer opens.
- * Z MODE reports reset totals to '0'. The Z counter is advanced. The cash drawer opens.
- * X2 reports read the period-to-date information, but do not reset the period-to-date totals. The Z counter is not advanced by X2 reports. The cash drawer opens.
- * Z2 reports read and reset the period-to-date totals, the Z counter is advanced by Z2 reports. The cash drawer opens.

* NOTE : YOU CAN NOT PRINT THE X2 AND Z2 REPORTS IN THE TRAIN MODE OPERATION

*** CASH DECLARATION OPERATION ***

If the compulsory cash declaration is programmed in the SYSTEM OPTION ADDRESS 13 (Page 38), the cash declaration must be performed in X/Z MODE positions prior to taking X/Z reports.

This is performed by depressing the " CASH/TEND " key, adding each type of cash payment in the drawer, entering the total via the 10-key numeric pad, and depressing the " CASH/TEND " key or " CHECK " key.

After each total is entered, a final depression of the " CASH/TEND " key will enter the information into the register and a X/Z position report.

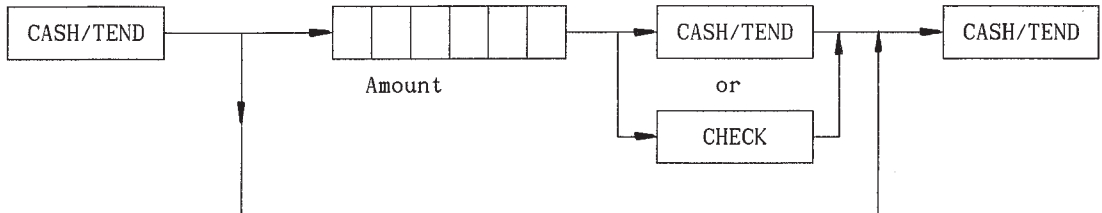

NOTE : After doing cash declaration in the X/Z mode, if you turn control key to any other position except the X/Z position, the cash declaration function will be lost. So if you want to print reports, you should perform the cash declaration operation again.

	DATE 12.26.'93	MON	
	* CASH DECLARATION *		
Cash declaration amount	CASH	=100.00	
	CASH	=200.00	
	CASH	=550.00	
Check declaration amount	CHECK	=100.00	
	CHECK	=10.00	
	TOTAL	=960.00	Declaration total amount
	CLERK 1	NO.000078	
	TIME 14:43	9999	

1. FINANCIAL REPORTS

- A. X mode financial reoprnt
Ensure the CONTROL LOCK is in the X position.
- B. Z mode financial reoprnt
Ensure the CONTROL LOCK is in the Z position.
- C. X2 financial report
Ensure the CONTROL LOCK is in the X position.
- D. Z2 financial reoprnt
Ensure the CONTROL LOCK is in the Z position.

1 — SUBTOTAL

1 — SUBTOTAL

2 0 1 — SUBTOTAL

2 0 1 — SUBTOTAL

* SAMPLE FINANCIAL REPORT *

DATE 12.26.'93	MON
X1 REPORT	0000

FINANCIAL	
DEPT.1: APPLE	
CNT X1	46.00
SALES AMT	=492.40
SALE RATE	49.89%
DEPT.2	
CNT X1	13.50

----- Z Report issuing counter
----- X Report

----- Dept. 1 & descriptor
----- Activity counter
----- Dept. sales total
----- Dept. % of sale

Integer part
(XXX.XX)
Fraction part

SALES AMT	=1.00
SALE RATE	0.10%
DEPT.10	
CNT	7.15
<GAL> AMT	@1.399
SALES AMT	=10.00
SALE RATE	1.01%
DEPT.15	
CNT X4	3.00
<HASH> AMT	=10.00
SALES AMT	=30.00
SALE RATE	3.03%

----- Gallonage dept. price
----- Gallonage sales total

+DEPT TTL	98.00
	=986.85
-DEPT TTL	0.00
	=0.00
ADJST TTL	98.00
	=986.85

----- Positive dept. counter/total
----- Negative dept. counter/total
----- Adjusted dept. counter/total

TAX1ABLE	=531.40	—————	Total sale taxable by tax 1
	10.000%	—————	Tax 1 rate
TAX1 AMT	=48.39	—————	Tax 1 amount
TAX2ABLE	=311.40		
	8.000%		
TAX2 AMT	=23.12		
TAX3ABLE	=70.00		
	6.000%		
TAX3 AMT	=4.02		
TAX4ABLE	=20.00		
	5.000%		
TAX4 AMT	=0.98		
Z 1	8	—————	% 1 key counter/total
	-4.65		
Z 2	1	—————	% 2 key counter/total
	-1.00		
Z 3	2	—————	% 3 key counter/total
	-0.00		
Z 4	3	—————	% 4 key counter/total
	-11.55		
NET	27	—————	Customer counter
	=947.00	—————	Net amount
TAX1 SHIFT	1		
	-10.00	—————	Tax 1 shift counter/total
TAX3 DEL	1		
	-10.00	—————	Tax 3 delete counter/total
RTN	4		
	-39.00	—————	Merchandise return counter/total
ERRCORR	1		
	-15.00	—————	Void 1 (Error correct)
PREV VD	1		
	-10.00	—————	Void 2 (Previous void)
MODE VD	1		
	-20.00	—————	Void 3 (Void outside of a sale)
CANCEL	3		
	=64.50	—————	Void 4 (Cancel)
GROSS	=1023.70	—————	Gross total
CASH SALES	25		
	=902.00	—————	Cash sales
CHECK SALES	3		
	=55.00	—————	Check sales

R/A	2	—————	R/A counter/total
	-20.00		
P/O	2	—————	P/O counter/total
	-10.00		
HASH AMT	3	—————	HASH dept. counter/total
	-30.00		
NPLU-PDPT	0	—————	(-) PLU linked to (+) dept. counter/total
	-0.00		
AUDACT	2	—————	Audaction counter/total
	-44.50		
NOSALE	17	—————	No sale counter
NON-ADD #	2469134	—————	Non-add number total
CASH-IN-D	-850.77	—————	Cash in drawer total
CASH DEC AMT	-850.00	—————	Cash declaration amount
OVER/SHORT	-0.77	—————	Cash declaration over/short
CHECK-IN-D	6	—————	Check in drawer total
	-115.00		
CHEK DEC AMT	-110.00	—————	Check declaration amount
OVER/SHORT	-5.00	—————	Check declaration over/short
CHARGE1 SALE	1	—————	
	-15.00		
CHARGE2 SALE	1	—————	Charge 2 sale counter/total
	-5.00		
CONV 1	-3.00	—————	Foreign currency total
CONV 2	-0.00	—————	
DRWR TTL	-985.77	—————	Drawer total

Clerk A — CLERK 1	27	—————	Clerk's customer counter
NET	-947.00	—————	Clerk's net sale total
NOSALE	17	—————	Clerk's no sale counter

CLERK 2	0		
NET	-0.00		
NOSALE	0		

CLERK 3	0		
NET	-0.00		
NOSALE	0		

		—————	GRAND total

MR. JOHN	0
NET	-0.00
NOSALE	0

GRAND	-1023.70
CLERK 1	NO.000079
TIME 14:47	9999

2. TIME REPORTS

- A. X mode time report
Ensure the CONTROL LOCK is in the X position.
- B. Z mode time report
Ensure the CONTROL LOCK is in the Z position.
- C. X2 time report
Ensure the CONTROL LOCK is in the X position.
- D. Z2 time report
Ensure the CONTROL LOCK is in the Z position.

2 — SUBTOTAL

2 — SUBTOTAL

2 0 2 — SUBTOTAL

2 0 2 — SUBTOTAL

* SAMPLE TIME REPORT *

DATE 12.26.'93	MON	
X1 REPORT	0000	

TIME		
TIME : 12:00		
CNT	7	Activity counter
SALES AMT	=555.00	Hour total
SALE RATE	56.80%	Hour % of sales
TIME : 13:00		
CNT	14	
SALES AMT	=266.00	
SALE RATE	27.22%	
TIME : 14:00		
CNT	6	
SALES AMT	=156.00	
SALE RATE	15.96%	
TOTAL CNT	27	Total sales counter/total
TOTAL AMT	=977.00	for all time period
CLERK 1	NO.000080	
TIME 14:47	9999	

3. PLU REPORT

- A. X mode PLU report
Ensure the CONTROL LOCK is in the X position.
- B. Z mode PLU report
Ensure the CONTROL LOCK is in the Z position.
- C. X2 PLU report
Ensure the CONTROL LOCK is in the X position.
- D. Z2 PLU report
Ensure the CONTROL LOCK is in the Z position.

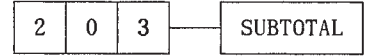
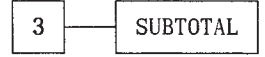
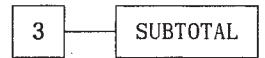

4. FROM/TO PLU REPORT

- A. X mode from/to plu report
Ensure the CONTROL LOCK is in the X position.



PLU NO. a

PLU NO. b

* a <= b

* SAMPLE PLU REPORT *

DATE 12.26.'93	MON
X1 REPORT	0000

ALL PLU	
PLU 10: ORANGE	
LINKED DEPT	1
CNT X1	13.50
SALES AMT	167.50

SALES AMT	-10.00
SALE RATE	3.50%
PLU 100	
LINKED DEPT	6
CNT X1	3.00
SALES AMT	-15.00
SALE RATE	5.26%

TOTAL CNT	29.00
TOTAL AMT	-285.00

CLERK 1	NO.000081
TIME 14:47	9999

PLU NO. & descriptor

Linked dept.

Activity counter

PLU sale total

PLU % of sales

PLU total activity counter/total

* SAMPLE FROM/TO PLU REPORT *

DATE 12.26.'93	MON
X1 REPORT	0000

FROM/TO PLU	
PLU 10: ORANGE	
LINKED DEPT	1
CNT X1	13.50
SALES AMT	-167.50
SALE RATE	58.77%
PLU 20	
LINKED DEPT	2
CNT X2	11.50
SALES AMT	-92.50
SALE RATE	32.45%

TOTAL CNT	25.00
TOTAL AMT	-260.00

CLERK 1	NO.000082
TIME 14:47	9999

5. CASH IN DRAWER REPORT

- A. X mode cash-in-drawer report
Ensure the CONTROL LOCK is in the X position.

4 — SUBTOTAL

6. CHECK IN DRAWER REPORT

- A. X mode check-in-drawer report
Ensure the CONTROL LOCK is in the X position.

5 — SUBTOTAL

7. DAILY REPORT

- A. X mode daily sales report
Ensure the CONTROL LOCK is in the X position.
- B. Z mode daily sales report
Ensure the CONTROL LOCK is in the Z position.

6 — SUBTOTAL

6 — SUBTOTAL

* SAMPLE CASH IN DRAWER REPORT *

```

DATE 12.26.'93  MON
X1 REPORT      0000
-----
CASH-IN-DRAWER
TOTAL          -850.77
CLERK 1      NO.000083
TIME 14:47   9999
    
```

* SAMPLE DAILY REPORT *

```

DATE 12.26.'93  MON
X1 REPORT      0000
-----
DAILY SALES
DAY : 25
CNT           25
SALES AMT    -887.00
DAY : 26
CNT           2
SALES AMT    -90.00
TOTAL CNT     27
TOTAL AMT    -977.00
CLERK 1      NO.000085
TIME 14:47   9999
    
```

* SAMPLE CHECK IN DRAWER REPORT *

```

DATE 12.26.'93  MON
X1 REPORT      0000
-----
CHECK-IN-DRAWER
CNT            6
TOTAL         -115.00
CLERK 1      NO.000084
TIME 14:47   9999
    
```

Activity counter —
Daily total —

All daily
counter/total —

8. INDIVIDUAL CLERK REPORT

- A. X mode clerk report
Ensure the CONTROL LOCK is in X position.
- B. Z mode clerk report
Ensure the CONTROL LOCK is in Z position.
- C. X2 clerk report
Ensure the CONTROL LOCK is in X position.
- D. Z2 clerk report
Ensure the CONTROL LOCK is in Z position.

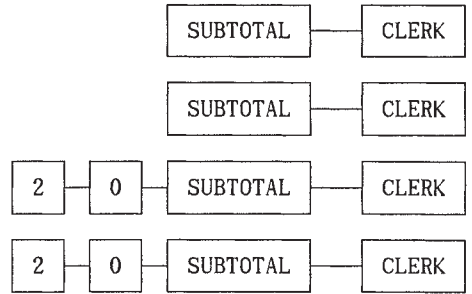

* SAMPLE INDIVIDUAL CLERK REPORT *

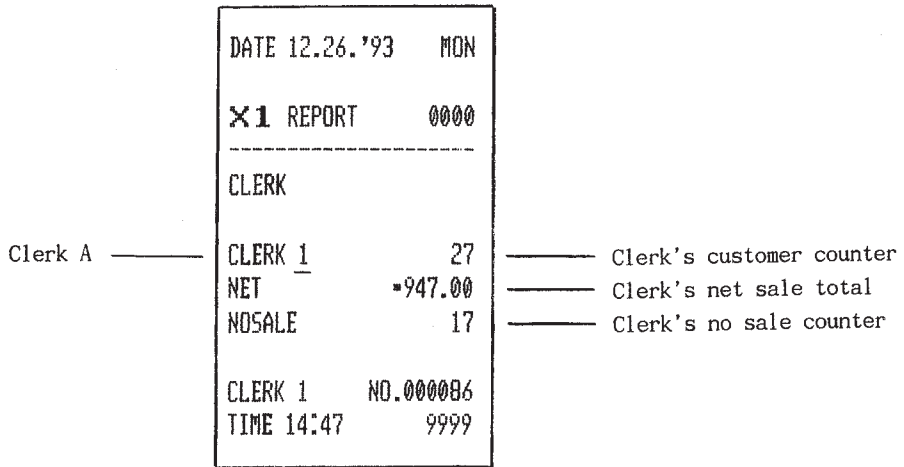

* Optional full clerk report (SYSTEM OPTION 11) *

DATE 12.26.'93	MON
X1 REPORT	0000

CLERK	
CLERK 1	27
NET	-947.00
Z 1	8
	-4.65
Z 2	1
	-1.00
Z 3	2
	-0.00
Z 4	3
	-11.55
CASH-IN-D	-850.77
CHECK-IN-D	6
	-115.00
CHARGE1 SALE	1
	-15.00
CHARGE2 SALE	1
	-5.00
CONV 1	-3.00
CONV 2	-0.00
DRWR TTL	-985.77
RTN	4
	-39.00
ERRCOR	1
	-15.00
PREV UD	1
	-10.00
MODE UD	1
	-20.00
CANCEL	3
	-64.50
AUDACT	2
	-44.50
NOSALE	19
CLERK 1	NO.000094
TIME 14:49	9999

GLOSSARY

ACTIVITY COUNTER	: The activity counter keeps track of the number of items or entries is made on a department, PLU or function key.
AUDACTION	: Refers to the total of all negative sale transactions.
COMPULSORY	: When an operation is programmed compulsory, a function(ie. Non-add number entry) must be performed in order to complete the operation.
CONSECUTIVE NUMBER	: A number appears at the bottom of each receipt and after each transaction on the journal tape. This number increases by one with each transaction, report, or scan.
DEPARTMENT(OPEN)	: An open department is a department which stores its own activity count and amount total, and has a compulsory amount entry.
DEPARTMENT(PRESET)	: A preset department is a department which stores its own activity count and amount total, and has a programmed price.
DETAIL	: The detail tape records all of the operations on the register. This is the owners copy of all register activity.
HALO	: The high amount lock-out (HALO) limits the amount allowed to be entered in a department, PLU, or function key.
HASH FUNCTION	: Hash departments or PLU's add to the total of each sale and therefore are included in all media and drawer total. Like normal departments/PLU's, hash departments/PLU's also add into a total of all hash departments and PLU's on the financial report.
LINK	: Link is the ability to attach a PLU's activity to a department. The department sales total will include the activity of all its linked PLU's.
MEDIA	: Media is the form of payment made. I.E cash, check, or charge.
OVERRIDE	: Override is an operation used to bypass a programmed price or HALO.
POP-UP	: When a function is programmed as a POP-UP function, it is valid for the duration of a single sale only. At the completion of that sale, the function reverts back to its default condition.
POST TENDERING	: The post tendering feature allows the operator to use the ECR to compute change on cash transactions after the sale has been finalized.
PLU'S	: Price look-ups (PLU's) are accessed by indexing a code number and depressing the PLU key. PLU's may be programmed with preset or open price. PLU's record their own activity count and total on the PLU report and report with their linked department on the department and financial reports.
PRESET CASH	: Preset cash keys which enter their preset amount in cash and finalize the sale. These keys must be programmed to operate as cash key.
RECEIPT	: A receipt is a printed tape given to the customer as a record of the sale transaction.

- REGISTER NUMBER : The register number is a programmable number which prints on receipt and journal tapes. It identifies the electronic cash register the sale or report was performed on.
- STAY-DOWN : When a function is programmed as a stay-down function, it is valid until changed. A stay-down clerk remains signed on until either signed off, or another clerk is signed on. A stay-down level is in effect until another level key is depressed.
- VALIDATION : A validation is a one-line print-out on an inserted slip verifying an operation.

TROUBLE SHOOTING

Check the following items if the cash register does not work correctly.

- * Is the power cord plugged into the mains socket correctly ?
- * Is the wall outlet supplying power ?
Try plugging in another appliance.
- * Is the CONTROL LOCK in the correct position ?
- * Did you change the position of the CONTROL LOCK during registration of the transaction ?
If you set the CONTROL LOCK to another position while registration is in progress an error condition will occur.
Return to the previous CONTROL LOCK position and press the correct keys to finalize the original transaction before changing the CONTROL LOCK setting.

MEMORY PROTECTION BATTERY

Totalized sales and other items are protected during power failures by a built in memory protection battery.

The memory protection battery is charging when the power is on and discharging when the power is off. This causes the capacity of the battery to decrease after approximately one year of use.

NOTE : A WEAK BATTERY HAS THE POTENTIAL OF LOSING VALUABLE TRANSACTION DATA.

A label on the back of the cash register shows the normal service period of the battery installed in your cash register.

SPECIFICATION

- * POWER : AC 220 - 240 V, 50 Hz
- * CABINET : ABS (V0)
- * PRINTER : ERP-300 : 2 STATION DOT-MATRIX PRINTER
- * DISPLAY : FRONT 10 DIGITS / REAR 9 DIGITS
- * DRAWER : METAL (8 COINS / 4 BILLS)
- * WEIGHT : 18 Kg
- * DIMENSION : SET - 380 (D) x 444 (W) x 211 (H)
DRAWER - 400 (D) x 450 (W) x 98 (H)
- * USAGE CONDITION : TEMPERATURE - 0 °C - 40 °C
HUMIDITY - 10 % - 90 %
- * NOISE : UNDER 70 dB

THE FABRICATION OF REWIND SPINDLE

* TO FABRICATE THE REWIND SPINDLE FOLLOW THESE STEP.

1. LOCATE THE BLACK PLASTIC REWIND SPINDLE ① IN THE STYROFOAM PACKING MATERIAL.
2. LOCATE THE BLACK PLASTIC REWIND SPINDLE ② IN THE MANUAL BAG.
3. FABRICATE THE BLACK PLASTIC REWIND SPINDLE ① AND ② AS SHOWN IN THE ILLUSTRATION.

